

MARK DISINFECTATION UNIT (MDU)

0661045_R01

Technical manual **EN**

Technisches Handbuch **DE**

Livret technique **FR**

Technisch boek **NL**























Instrukcja techniczna **PL**

Manual tehnic **RO**















SAFETY CONSIDERATIONS

Please read the following safety instructions before installation. And ensure that the unit is installed correctly. Please observe all instruction in order to avoid any injury or damage to equipment or property. The information in this document is subject to change without notice. The most recent version of this manual is always available at www.markclimate.com/downloads.

Safety attentions			
The following symbols indicate potential levels of caution.			
 Warning	Situations with a risk or death or serious injure.	 Attention	Situations with a risk of injury or equipment/ property damage.
The following symbols indicate compliance which must be observed			
	Not allowed or Stop	 Must follow	 or obliged
 Warning			
	Installation to be carried out by qualified person, End Users must not install, move or re-install this equipment by themselves.		An anti-bird net or similar device should be installed to outside vents. Ensure there are no obstructions to or in the ducts.
	Installation engineers must follow this manual strictly. Improper action can create a health hazard and reduce efficiency of the unit.		Fresh air vent must be far enough away from any flue gas discharge or areas where hazardous vapors are present.
	Unit must be installed strictly following this manual and mounted to a weight bearing surface for the weight of the unit.		Electric engineering must follow national regulations and the manual, use special cables. Less capacity cables and improper engineering can cause electric shock or fire.
	During maintenance or repair, the unit and circuit breaker must be switched off. Other-wise electric shock could occur.		Ground wire cannot be connected to gas pipe, water pipe, lighting rod or telephone line etc. Incorrect grounding can cause electric shock.
 Attention			
	Power cable and wires must be installed by a qualified electrical engineer. Improper connection can cause over heating. Fire and loss of efficiency.		To avoid condensation, insulation should be fitted to fresh air ducts. Other ducting may also require insulation depending on dew point conditions.
	Insulation between the metal ducting and wall penetration must be installed if the ducting penetrates metal wall cladding, to avoid risk of electric shock or current leakage.		The cover of wiring box must be pressed down and closed to avoid dust and dirt entering. Excess dust and dirt can cause over-heating of terminals and result in fire or electric shock.
	Use only approved installation hardware and accessories. Failure to observe can result in fire risk, electric shock and equipment failure.		Where the unit is positioned, at high level in a hot humid situation. Please ensure sufficient ventilation is available.
	The outdoor ducts must be installed facing downwards to avoid rain water entering. Improper installation can cause water leakage.		Correctly sized MCB must be fitted to the unit suitable earth leakage protection should also be installed to avoid risk of electric shock or fire.

SAFETY CONSIDERATIONS

 Attention	
 Do not install the unit in an extremely humid conditions, as it may result in electric shock and pose a fire risk.	 Do not use the units as the primary kitchen extract grease and fatty deposits can block the heat exchanger, filter and pose a fire risk.
 Do not install the unit in areas there any poisonous or caustic gases are present.	 Do not install the unit near open flame as it may result in over heating and pose a fire risk.
 Acidic or alkali environments can cause poisoning or a fire.	 Rated supply voltage must be maintained, otherwise this may cause fire.

 Warning	
 This appliance can be used by children aged from 8 years and above and persons with reduced physical, sensory or mental capabilities or lack of experience and knowledge if they have been given supervision or instruction concerning use of the appliance in a safe way and understand the hazards involved.	
 Children shall not play with the appliance.	 Cleaning and user maintenance shall not be made by children without supervision.
 Means for disconnection must be incorporated in the fixed wiring in accordance with the wiring rules.	 Prior to cleaning or other maintenance, the appliance must be disconnected from the supply mains.

SPECIFICATIONS

Model	MDU 500	MDU 1000
Air flow (m3/h)	400~600	600~1300
External pressure (Pa)	5	5
Voltage (V)	230	230
Input Power (W)	6	7.4
Weight (Kg)	6	7.8

DIMENSIONS

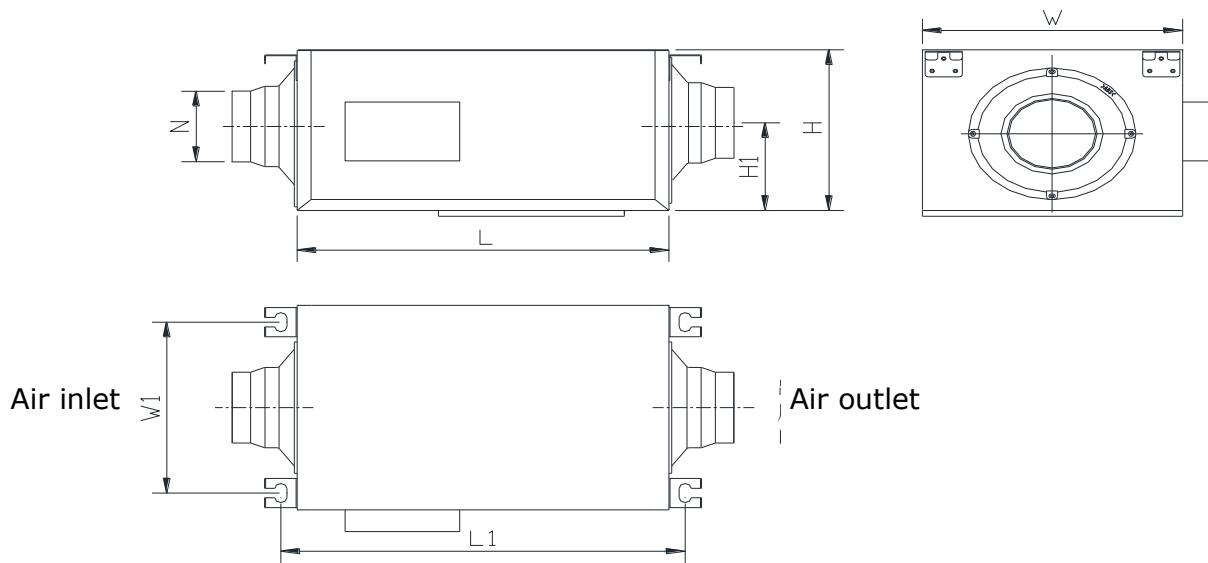

EN

Model	L	L1	W	WI	H	HI	N
MDU 500	400	433	320	282	290	145	198
MDU 1000	400	433	350	291	310	155	242

INSTALLATION CONSIDERATIONS

1. Installed in the air duct in series connection and used in conjunction with other ventilation equipment (such as fresh air ventilator; air purification box, etc.).
2. Regardless of any reason for delaying the installation of the disinfection box and the short-term or long-term storage of the disinfection box on site, corresponding protective measures must be taken to prevent construction dust and gravel from entering the machine.
3. Do not install near the water heater.
4. The following phenomena should be avoided in the installation pipeline project

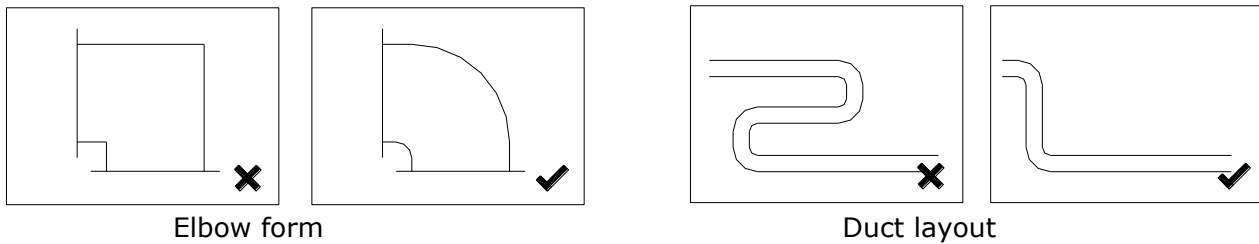

5. Installation location: The equipment is connected with other ventilation equipment by air pipes, and no air supply outlet or return air inlet should be installed between the two equipments.
6. Air duct connection: If the diameter of duct diameter is not consistent with the air duct diameter of the ventilation system, please use the duct reducer for transitional connection. The connection between different pipe diameters should comply with the design specifications of ventilation ducts (ie less than 15 ° on both sides)
7. Air volume adjustment: The air valves should be installed in the main duct to adjust the air volume, so as to ensure that each fan in the ventilation system does not operate in overload. The higher the air volume, the greater load on the disinfection.
8. It's recommended to use the ventilation equipment with primary filters and F9 filters to work together with the disinfection box for better disinfection effect.

ELECTRICAL INSTALLATION



Warning

Power must be isolated during installation and before maintenance to avoid injury by electric shock. The specifications of cables must strictly match the requirements, otherwise it may cause performance failure and danger of electric shock or fire.

EN

Power supply is AC220V/50HZ/1 Phase.



Warning

We do not accept any liability for any problems caused by the user's self and non-authorized re-engineering to the electrical and control systems.

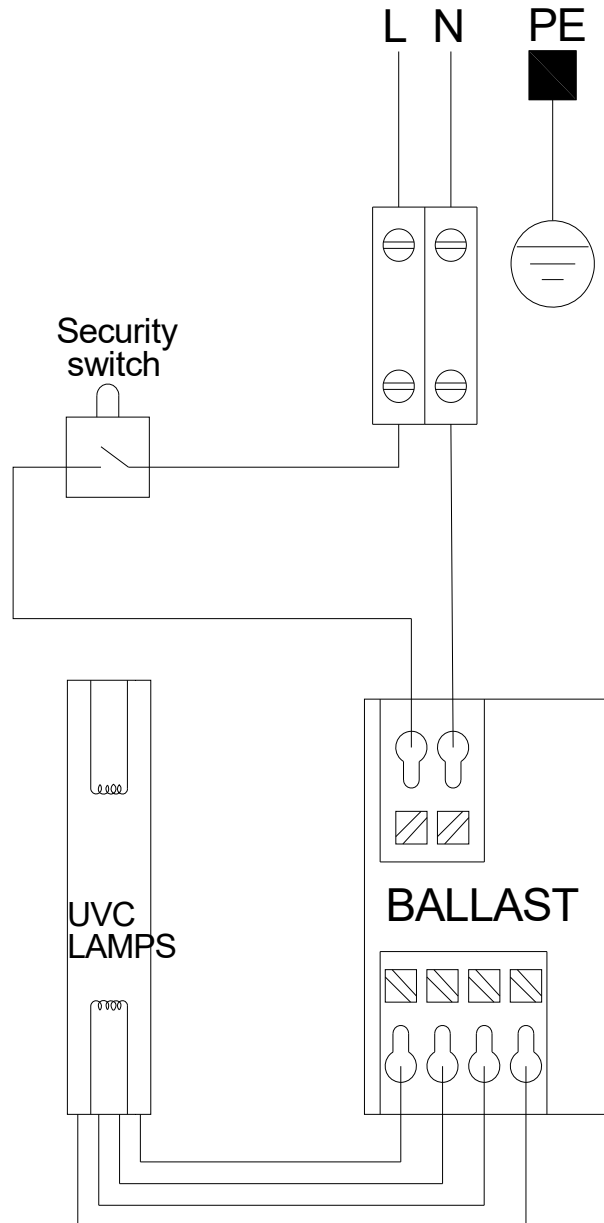

ELECTRICAL INSTALLATION

COMMISSIONING

After the installation project is completed, please follow the following steps for commissioning (please entrust a professional to carry out).

1. First, check if the equipment wiring and power supply wiring are correct, to make sure all the wiring are correct before commissioning.
2. Use a multimeter to measure whether the power supply is normal.
3. When abnormality occurs during the commissioning, in order to prevent electric shock, please turn off the equipment immediately, and switch off the main power supply and re-check.

FEATURES

Ultraviolet light + photocatalyst filter can promote chemical substances reaction, and use light energy to convert into energy required for chemical reaction, so that oxygen and water molecules can be excited into oxidative OH and O₂ free negative ions, which can decompose the harmful gas like benzene, formaldehyde, etc. and destroy the molecular structure of DNA and RNA in the cells of microorganisms, to make them lose the ability for reproduction, and kill the growing cells, achieving the purpose of sterilization and disinfection and converting them into harmless carbon dioxide and water.

PRECAUTIONS

1. During maintenance, before opening the inspection cover, be sure to turn off the power, and then perform maintenance and inspection.
2. During the maintaining and repairing, be sure to wear gloves to avoid injury.
3. During maintenance, please fix the ladder to avoid falling.

INSTALLATION INSTRUCTIONS

(I) INSTALLATION WITH ENERGY RECOVERY VENTILATOR

- 1, Fresh air disinfection box can be used in conjunction with energy recovery ventilator, and work together with interlock control.
- 2, Fresh air disinfection box can sterilize the outdoor or indoor polluted air.
- 3, Fresh air disinfection box is recommended to be installed on the air supply and exhaust ducts first.
- 4, Both ends of fresh air disinfection box need to be connected to the main pipe with hoses.

EN

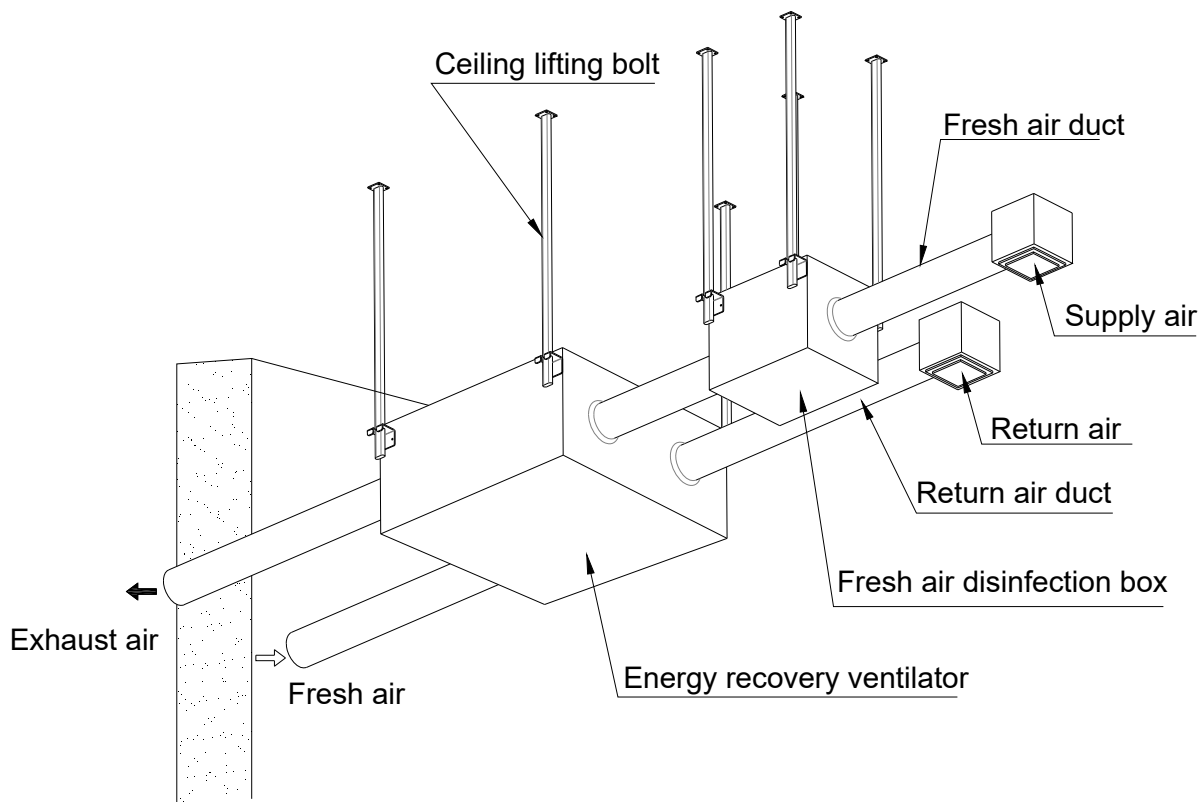

INSTALLATION INSTRUCTIONS

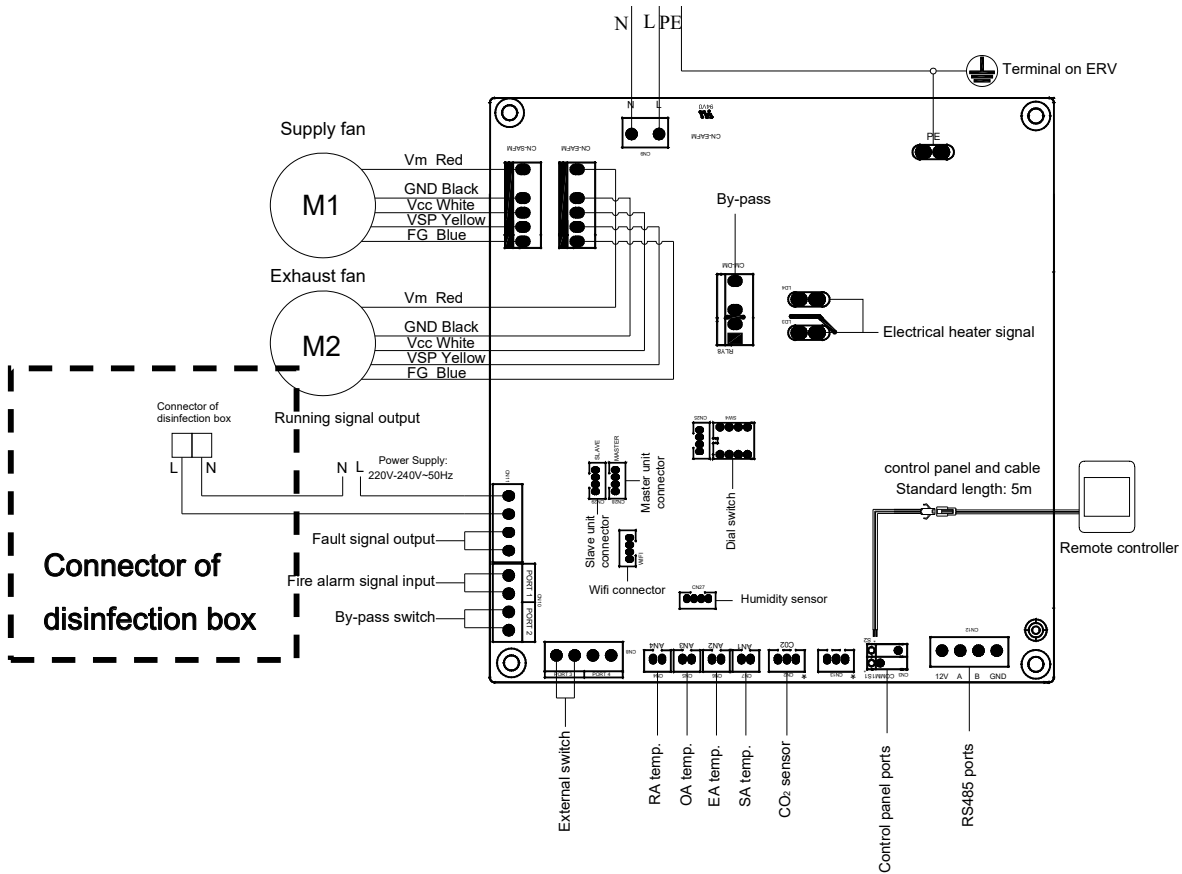

Interlock with ERV controller (DC motor type)

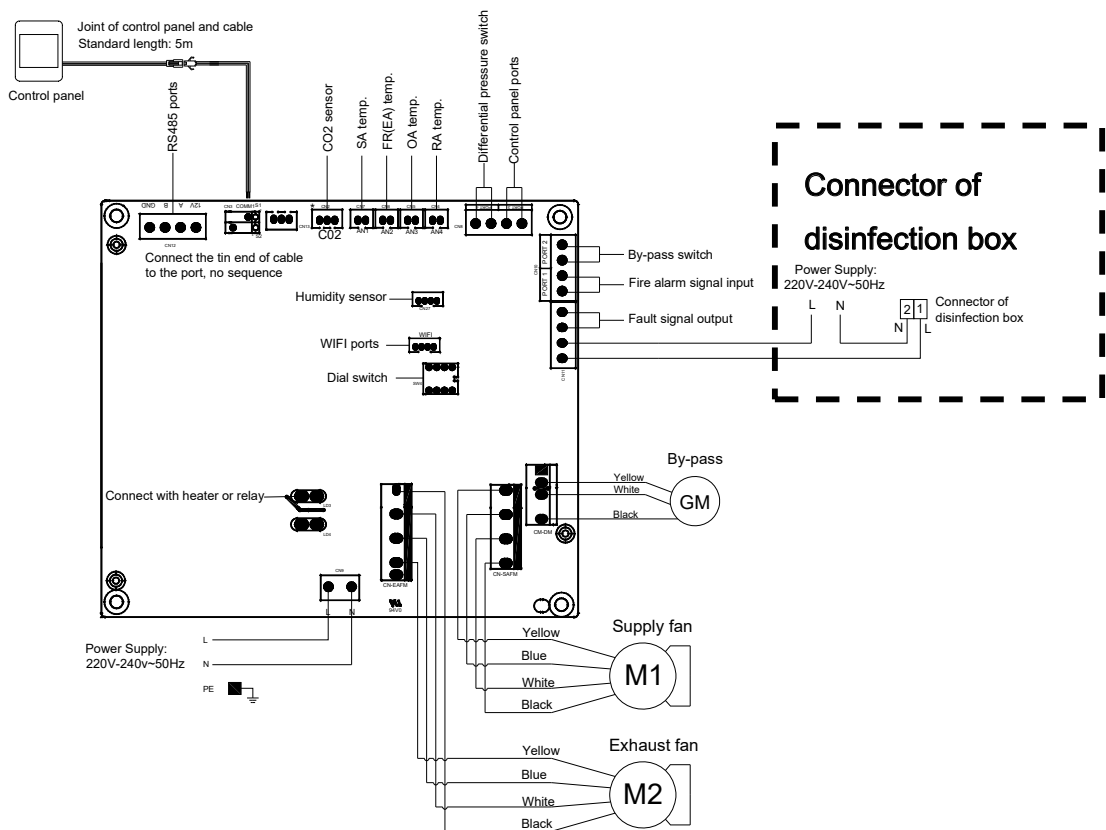

Interlock with ERV controller (AC motor type)

INSTALLATION INSTRUCTIONS

(2) INSTALLATION WITH FRESH AIR FILTRATION BOX

- 1, Fresh air disinfection box can be used in conjunction with fresh air filtration box, and work together with interlock control.
- 2, Fresh air disinfection box can sterilize the outdoor or indoor polluted air.
- 3, Fresh air disinfection box is recommended to be installed after the filtration box.
- 4, Both ends of fresh air disinfection box need to be connected to the main pipe with hoses.

EN

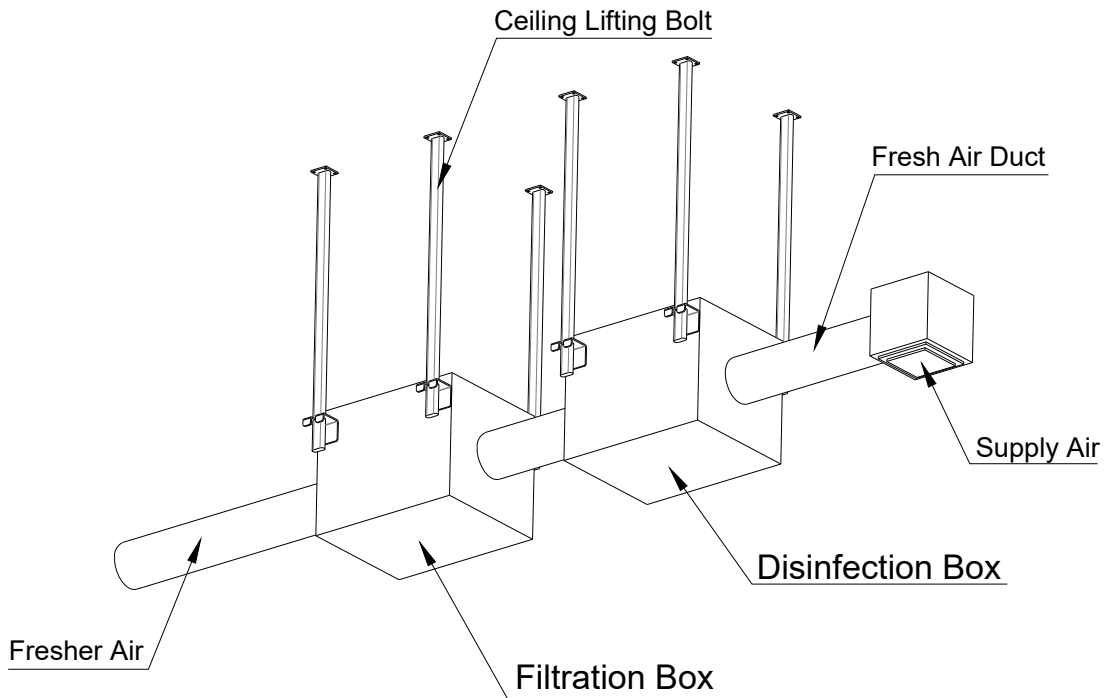

Fresh air filtration box with button controller:

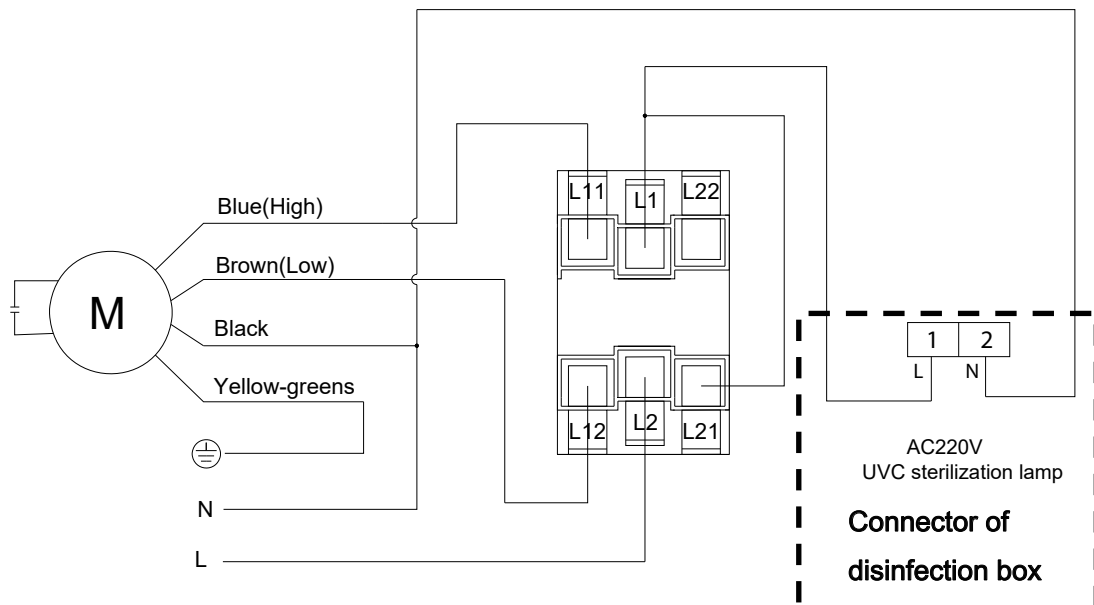

CONTROLS

INDEPENDENT CONTROL

- 1, The disinfection box can be used independently with ON/OFF controller.
- 2, The disinfection box can sterilize the outdoor or indoor polluted air.
- 3, The disinfection box is recommended to be installed after the ventilator or blower.
- 4, Both ends of the disinfection box need to be connected to the main pipe with hoses.

OPTIONAL (I): TOUCH SCREEN CONTROL PANEL

Reference picture:



Installation dimensions:

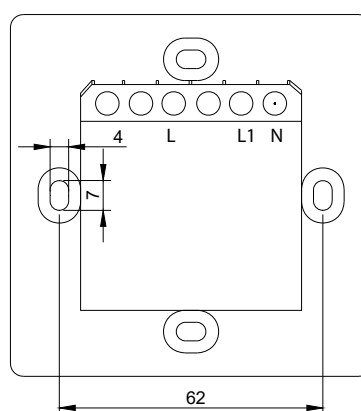
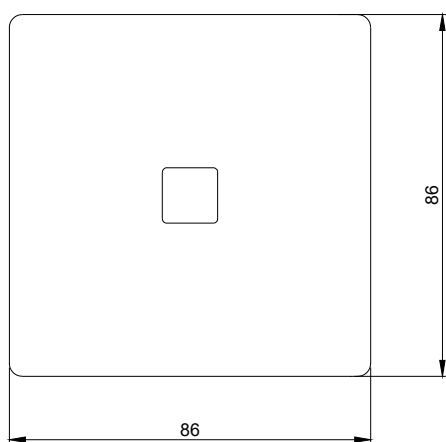

Wiring diagram:

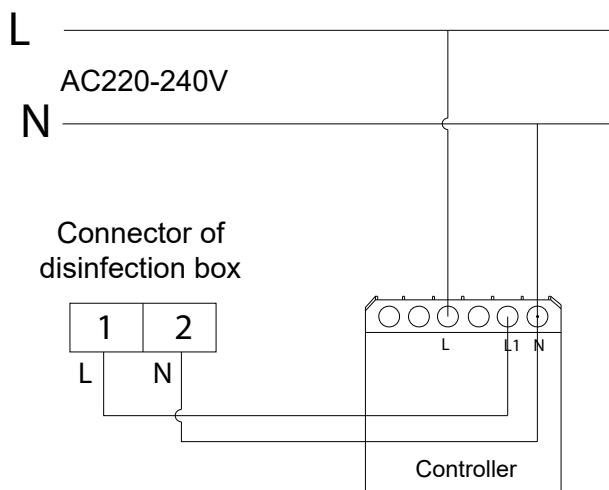

Connect to on/off controller

CONTROLS

OPTIONAL (2): BUTTON CONTROL PANEL

Reference picture:



EN

Installation dimensions:

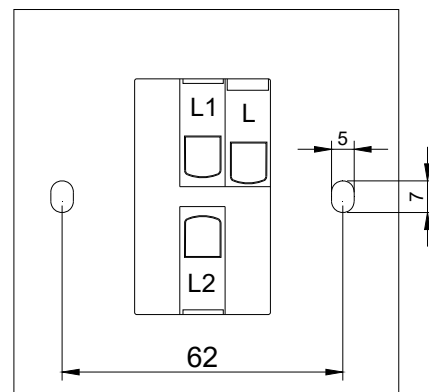
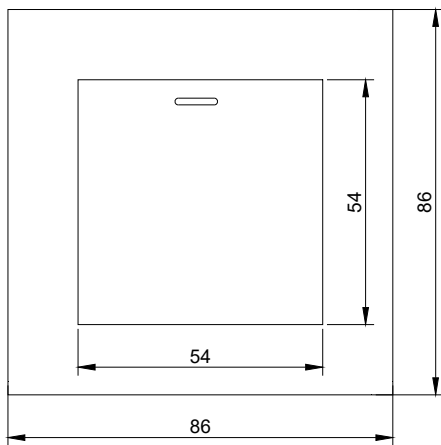



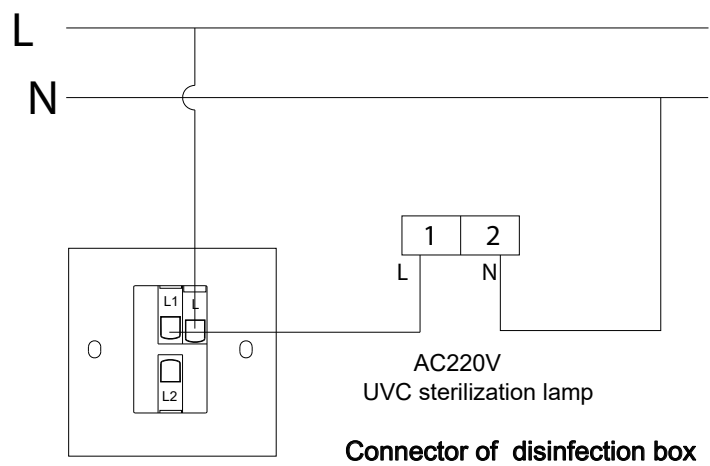



















Wiring diagram:









BEDIENUNGSANLEITUNG







Lesen Sie die Bedienungsanleitung sorgfältig vor der Installation durch. Achten Sie darauf, dass das Gerät korrekt installiert wird. Beachten Sie die Angaben, um Verletzungen und Schäden am Gerät und Personen zu vermeiden. Die Informationen in diesem Dokument können sich ohne vorherige Ankündigung ändern. Die neueste Version dieses Handbuchs finden Sie immer auf unserer Internetseite unter www.mark.de/downloads

Sicherheitshinweise			
Die folgenden Symbole zeigen mögliche Gefährungsstufen an.			
 Warning	Situationen mit dem Risiko von Tod oder lebensgefährlichen Verletzungen	 Attention	Situationen mit dem Risiko von Personen- oder/ materiellem Schaden
Die folgenden Symbole geben Anweisungen, die beachtet werden müssen			
	Verbot	 nach Anweisung handeln	 Anweisung muss verbindlich eingehalten werden
 Warnung vor Gefahrenstellen			
	Die Installation muss durch qualifizierte Fachkräfte erfolgen. Endverbraucher dürfen das Gerät nicht selber installieren, umbauen oder neu in Betrieb nehmen.		Ein Vogelschutzgitter oder ein baugleiches Produkt muss auf der Außen- und Fortluftöffnung angebracht werden. Stellen Sie sicher, dass sich keine Hindernisse auf oder in den Kanälen befinden.
	Installateure müssen diesen Anweisungen strikt folgen. Nichtbefolgen kann zu gesundheitlichen Schäden führen und die Effizienz der Geräte mindern.		Die Außenluftzufuhr muss mit entsprechendem Abstand vom Schornstein oder Bereichen in denen gefährliche Dämpfe vorhanden sind, erfolgen.
	Die Installation muss genau nach dieser Anweisung montiert werden. Auf Grund des Gewichtes ist die Tragfähigkeit der Decke entsprechend zu prüfen!		Elektrotechnisch muss entsprechend der nationalen Vorschriften und dem Handbuch, Spezialkabel verwendet werden. Schlechte Kabel und falsche Installation können zu einem Stromschlag oder Feuer führen.
	Während der Wartung oder Reparatur muss das Gerät von der Netzspannung getrennt werden. Ansonsten kann es zu Stromschlägen kommen.		Erdungskabel dürfen nicht auf Gasleitungen, Wasserleitungen, Licht- und Telefonleitungen usw. angeschlossen werden. Falsche Erdung kann einen elektrischen Schock verursachen.
 Achtung			
	Stromkabel müssen durch qualifiziertes Fachpersonal verlegt werden. Nicht fachgerechte Installation, kann Überhitzung verursachen. Dadurch kann es zu Feuer und Verlust der Leistung kommen.		Zur Vorbeugung von Kondensat, müssen die Frischluftkanäle isoliert werden. Gegebenfalls können/müssen auch andere Kanäle isoliert werden, das ist abhängig vom Taupunkt.
	Es muss eine Isolierung zwischen den Metallkanälen und Metallwanddurchführung angebracht werden, um das Risiko eines elektrischen Schlag oder von Krichstrom vorzubeugen.		Der Deckel der Verdrahtungsdose muss eingedrückt und geschlossen werden, um Eindringen von Staub und Schmutz zu vermeiden. Übermäßiger Staub und Schmutz können zu Überhitzung der Buchsen, Bränden und Stromschlägen führen.
	Verwenden Sie nur zugelassenes Montagematerial und Zubehör. Bei Nichtbeachtung besteht erhöhtes Risiko von Feuer, Stromschlag und Verlust der Geräte.		Wenn das Gerät in einer Umgebung mit großer Hitze oder Feuchte verbaut wird, müssen Sie für ausreichende Belüftung sorgen.
	Die Außenluftkanäle müssen so installiert werden, dass das Eindringen von Regenwasser verhindert wird. Bei Nichtbeachtung kann das zu Wasserschäden führen.		Leitungsschutzschalter in der richtigen Abmessung, müssen am Gerät angebracht werden. Ebenso muss ein Erdungskabel installiert werden, damit es nicht zum elektrischen Schlag oder Brand kommt.

BEDIENUNGSANLEITUNG

DE

 Achtung	
 Installieren Sie das Gerät nicht in extrem feuchter Umgebung, diese kann zu elektrischen Kurzschluss oder Brand führen.	 Setzen Sie das Gerät nicht als Fettabsaugung im Küchenbereich ein. Fettablagerungen können den Wärmetauscher und Filter blockieren, es besteht Brandgefahr.
 Die Geräte dürfen nicht in Bereichen installiert werden, wo giftige oder ätzende Dämpfe entstehen.	 Installieren Sie das Gerät nicht in der Nähe von offenem Feuer, das führt zu Überhitzung und Brandgefahr.
 Säure- oder alkalische Umgebungen können Vergiftungen oder Brand verursachen.	 Nominale Versorgungsspannung muss eingehalten werden, sonst kann Feuer entstehen.

 Achtung	
 Dieses Gerät kann von Kindern ab 8 Jahren und Personen mit eingeschränkten körperlichen, sensorischen oder geistigen Fähigkeiten oder mangelnder Erfahrung und Wissen verwendet werden, sofern sie beaufsichtigt werden oder in die sichere Verwendung des Geräts eingewiesen wurden und die Gefahren verstehen.	
 Kinder dürfen nicht mit dem Gerät spielen.	 Reinigung und Wartung durch den Benutzer, dürfen nicht von Kindern ohne Aufsicht durchgeführt werden.
 Einrichtungen zum Trennen des elektrischen Anschlusses müssen, gemäß den einschlägigen Normen und Richtlinien, in die Verdrahtung integriert werden.	 Vor der Reinigung oder sonstiger Wartung, muss das Gerät vom Stromnetz getrennt werden.

SPEZIFIKATION

Model	MDU 500	MDU 1000
Luftstrom (m3/h)	400~600	600~1300
externer Druck (Pa)	5	5
Spannung (V)	230	230
Elektroleistung (W)	6	7.4
Gewicht (Kg)	6	7.8

ABMESSUNG

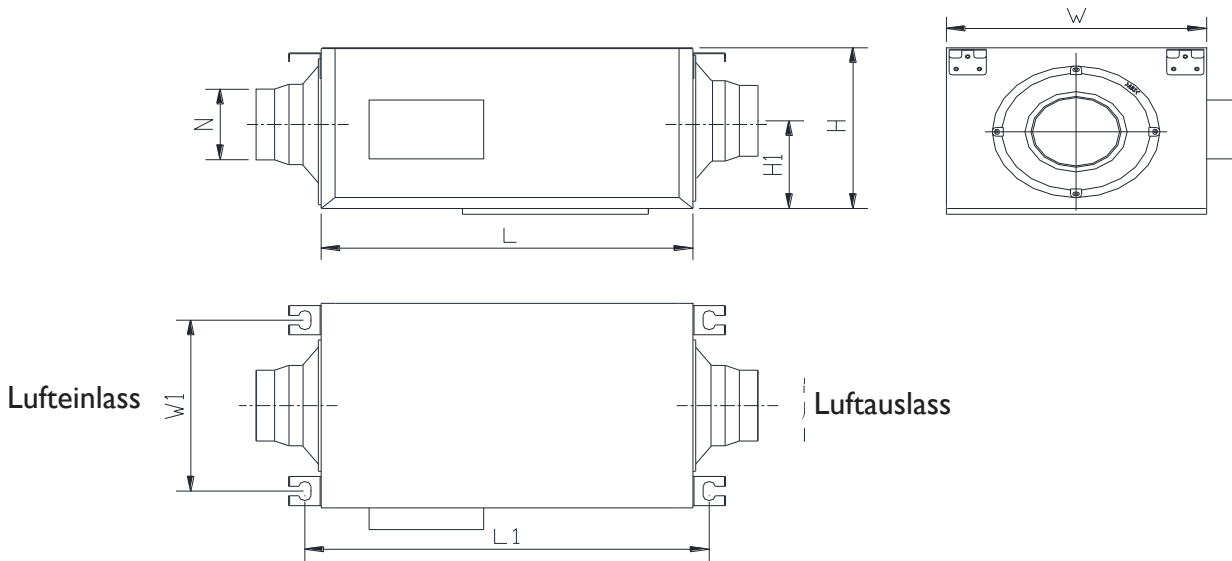

Model	L	L1	W	W1	H	HI	N
MDU 500	400	433	320	282	290	145	198
MDU 1000	400	433	350	291	310	155	242

INSTALLATION

1. Im Luftkanal in Reihe installiert und in Verbindung mit anderen Lüftungskomponenten verwendet, (wie Frischluftventilator, Luftreinigungssystem etc.).
2. Unabhängig vom Grund der verzögerten Installation oder der Kurz- oder Langzeitlagerung der Desinfektionsbox vor Ort, müssen entsprechende Schutzmaßnahmen getroffen werden, um ein Eindringen von Baustaub und Schutt zu verhindern.
3. Nicht in der Nähe von Warmwasserbereitern installieren.
4. Die folgenden Einbausituationen sollten schon bei der Kanalnetzplanung vermieden werden.

DE

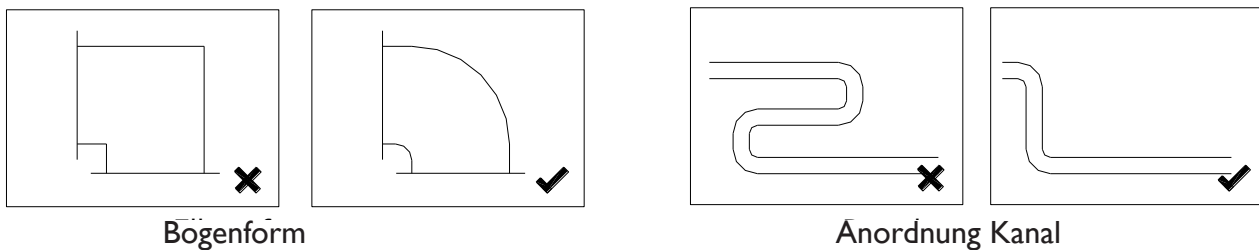

5. Installationsort: Das Gerät ist über Luftleitungen mit anderen Lüftungskomponenten verbunden. Zwischen den Komponenten darf kein Zuluftauslass oder Ablufteinlass installiert werden.
6. Luftkanalanschluss: Wenn der Durchmesser des Luftkanals nicht mit dem Durchmesser des Lüftungssystems übereinstimmt, verwenden Sie bitte ein Reduzierstück für den Anschluss. Die Verbindung zwischen verschiedenen Rohrdurchmessern sollte den Konstruktionspezifikationen von Lüftungskanälen entsprechen (d.h. auf beiden Seiten weniger als 15 °).
7. Luftvolumeneinstellung: Es sollten Volumenstromregler im Hauptkanal installiert werden, um den Volumenstrom zu regulieren und so sicherzustellen, dass die Ventilatoren im Lüftungssystem nicht überlastet werden. Je höher der Luftvolumenstrom, desto höher ist die Belastung der Desinfektion.
8. Es wird empfohlen, die Lüftungsgeräte mit Primärfiltern und F9-Filtern zu verwenden, um mit der Desinfektionsbox für einen besseren Desinfektionseffekt zu erreichen.

ELEKTRISCHE INSTALLATION



Achtung

Die Stromzufuhr muss während der Installation und vor der Wartung ausgeschaltet werden, um Verletzungen durch einen elektrischen Stromschlag zu vermeiden. Die Spezifikation der Kabel muss genau eingehalten werden, ansonsten kann das Vorhaben fehlschlagen, es besteht die Gefahr eines elektrischen Schlages oder Brandes.

Stromversorgung ist AC220V/50HZ/1-Phase.



Achtung

Wir übernehmen keine Haftung für elektrische Probleme und die des Betriebssystems, die durch privates und nicht autorisiertes Re-Engineering des Nutzers verursacht werden.

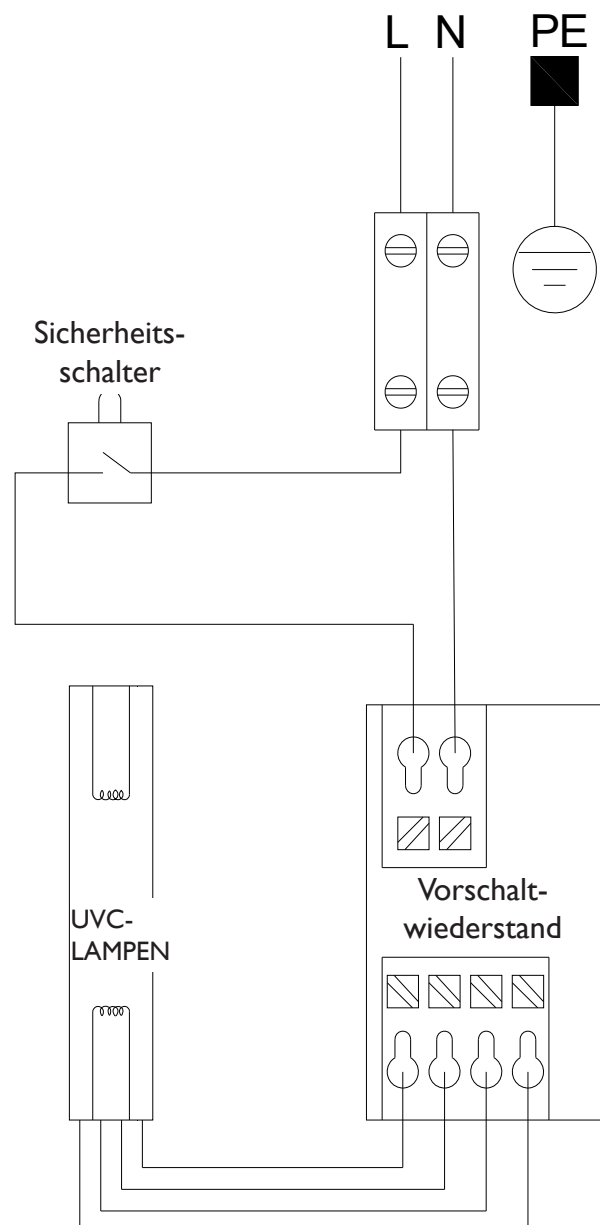

ELEKTRISCHE INSTALLATION

INBETRIEBNAHME

Befolgen Sie nach Abschluss der Installationsarbeiten, die folgenden Schritte zur Inbetriebnahme (bitte beauftragen Sie einen Fachmann mit der Durchführung).

1. Überprüfen Sie vor der Inbetriebnahme zunächst, ob die Geräteverkabelung und die Einspeisung korrekt durchgeführt wurde.
2. Verwenden Sie ein Multimeter, um die Stromversorgung zu überprüfen.
3. Wenn während der Inbetriebnahme Anomalien auftreten, schalten Sie das Gerät sofort aus, schalten Sie dafür die Hauptstromversorgung aus und überprüfen Sie die Spannungsfreiheit der Anlage, um einen Stromschlag zu vermeiden.

DE

EIGENSCHAFTEN

Ultraviolettes Licht + photokatalytischer Filter kann die Reaktion chemischer Substanzen fördern und Lichtenergie in freie Energie umwandeln, die für eine chemische Reaktion erforderlich ist. So werden Sauerstoff- und Wassermoleküle in oxidative OH- und O₂-, mit freien negativen Ionen, umgewandelt, die schädliche Gase wie Benzol, Formaldehyd usw. zersetzen können. Sie zerstören die molekulare Struktur von DNA und RNA in den Zellen von Mikroorganismen, um die Fähigkeit zur Reproduktion zu unterbinden und die wachsenden Zellen abzutöten. So wird das Ziel der Sterilisation und Desinfektion erreicht und die Mikroorganismen werden in harmloses Kohlendioxid und Wasser umgewandelt.

VORSICHTSMASSNAHMEN

1. Schalten Sie zu Beginn der Wartung und vor dem Öffnen der Revisionsöffnung, die Stromversorgung aus und führen Sie erst dann die Wartung und Inspektion durch.
2. Tragen Sie während der Wartung und Reparatur unbedingt Handschuhe, um Verletzungen zu vermeiden.
3. Bitte sichern Sie während der Wartung die Leiter, um einen Absturz zu vermeiden.

INSTALLATIONSANLEITUNG

(I) ANLAGE MIT ENERGIERÜCKGEWINNUNGSVENTILATOR

- 1, Die Frischluft-Desinfektionsbox kann in Verbindung mit einem Energierückgewinnungsventilatoren verwendet werden und arbeitet in Verbindung mit einer Verriegelungssteuerung.
- 2, Die Desinfektionsbox für Frischluft kann die verschmutzte Außen- oder Innenluft sterilisieren.
- 3, Es wird empfohlen, die Frischluft-Desinfektionsbox auf den Luftzufuhr- und Abfuhrkanälen zu installieren.
- 4, Beide Enden der Frischluft-Desinfektionseinheit müssen mit Schläuchen am Hauptkanal angeschlossen werden.

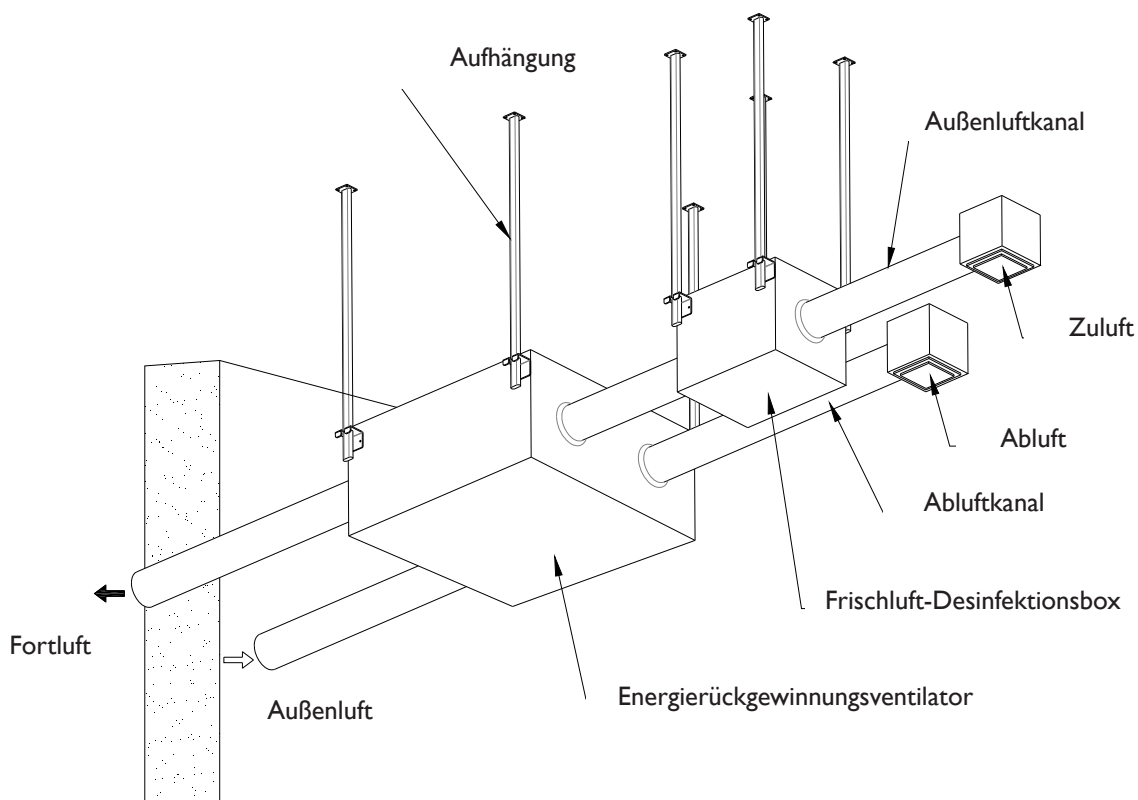

INSTALLATIONSANLEITUNG

DE

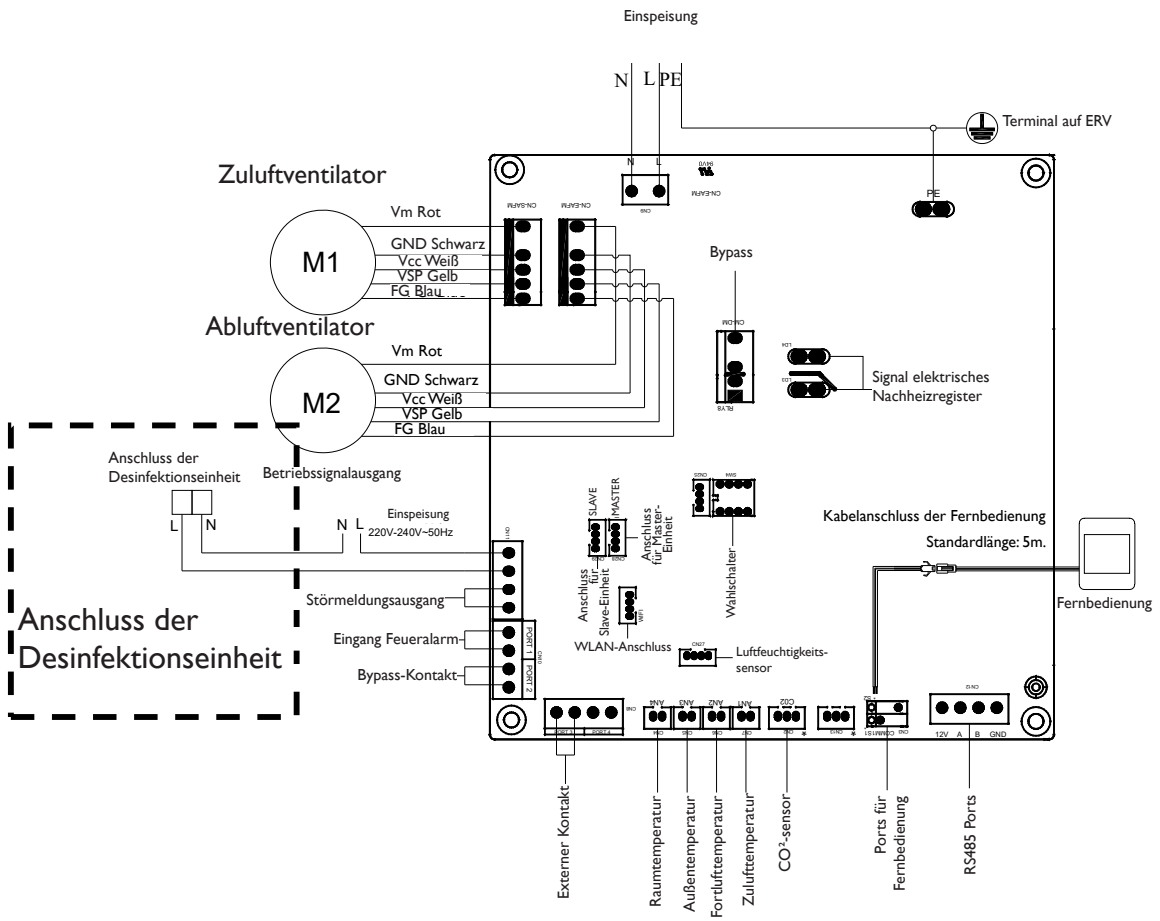

Verbindung mit ERV-Controller (für DC-Motoren)

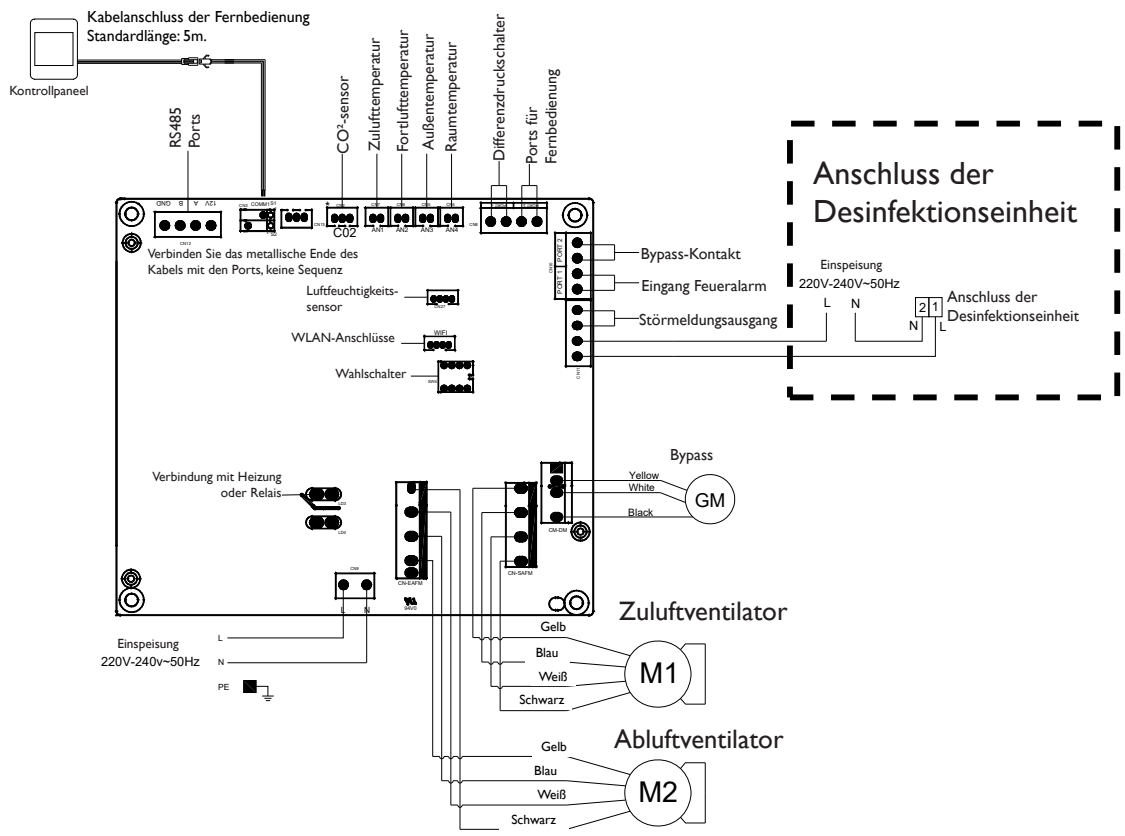

Verbindung mit ERV-Controller (für AC-Motoren)

INSTALLATIONSANLEITUNG

(2) INSTALLATION FRISCHLUFT-DESINFEKTIONSBOX

- 1, Die Frischluft-Desinfektionsbox kann in Kombination mit Frischluftfiltrationskasten verwendet werden und arbeitet in Verbindung mit einer Verriegelungssteuerung.
- 2, Die Desinfektionsbox für Frischluft kann die verschmutzte Außen- oder Innenluft sterilisieren.
- 3, Es wird empfohlen, die Frischluft-Desinfektionsbox nach der Filtrationsbox zu installieren.
- 4, Beide Enden der Frischluft-Desinfektionseinheit müssen mit Schläuchen am Hauptkanal angeschlossen werden.

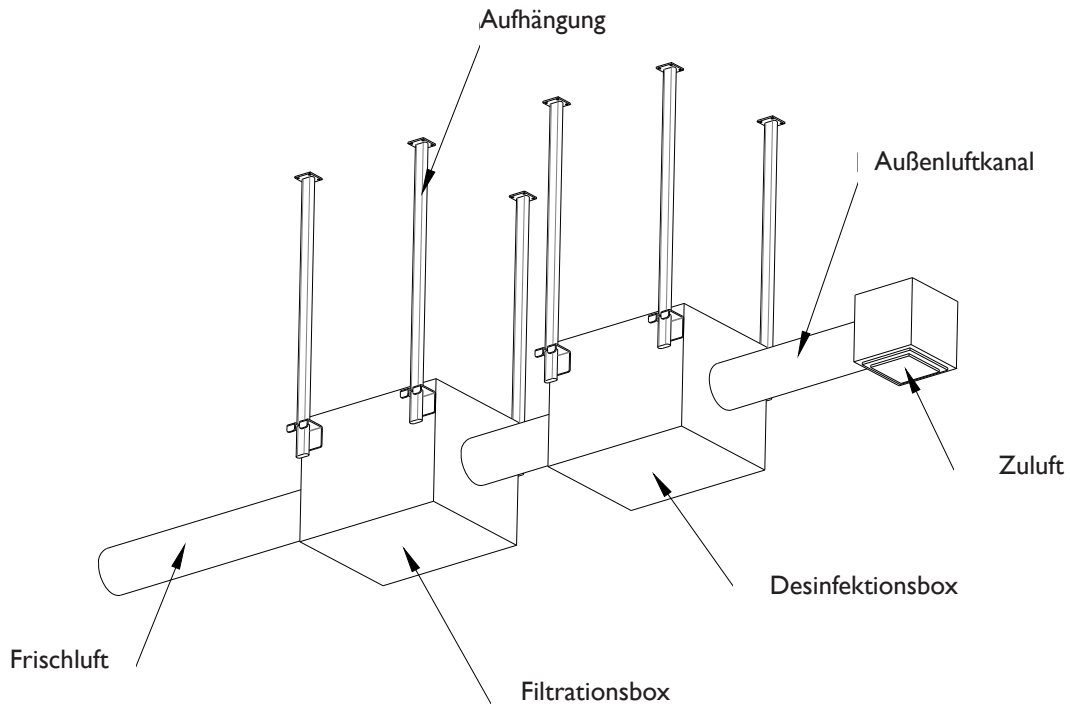

Frischluft-Filtrationsbox mit Bedienknopf:

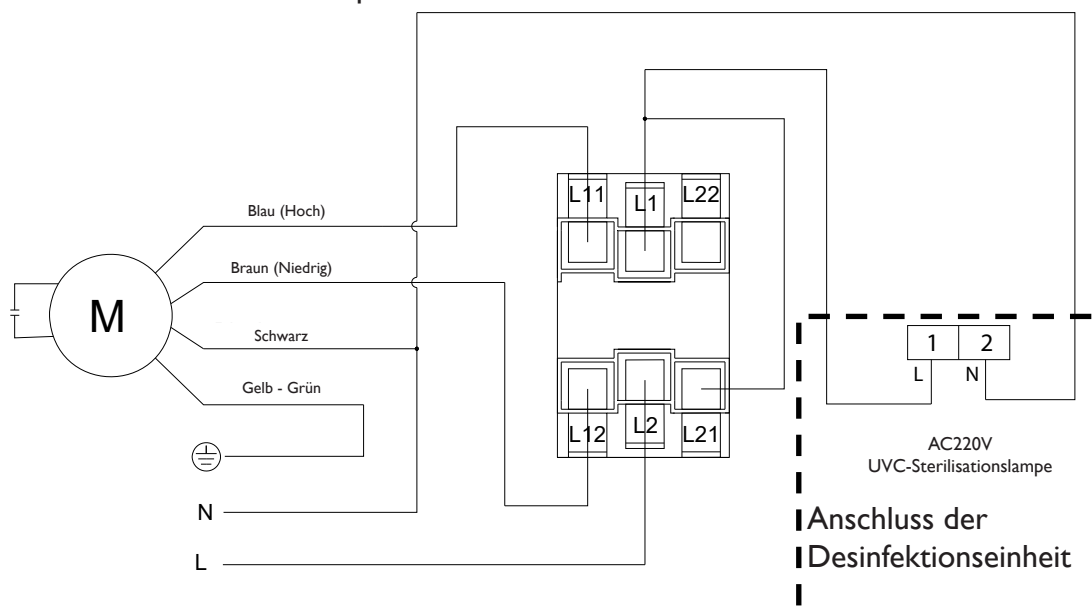

BEDIENUNG

UNABHÄNGIGE BEDIENUNG

- 1, Die Desinfektionsbox kann unabhängig durch Gebrauch des AN/AUS-Knopf benutzt werden.
- 2, Die Desinfektionsbox für Frischluft kann die verschmutzte Außen- oder Innenluft sterilisieren.
- 3, Es wird empfohlen, die Frischluft-Desinfektionsbox nach dem Ventilator zu installieren.
- 4, Beide Enden der Frischluft-Desinfektionseinheit müssen mit Schläuchen am Hauptkanal angeschlossen werden.

DE

OPTIONAL (I): TOUCH SCREEN BEDIENUNGSPANEEL

Referenzfotos:



Geräte Abmessungen:

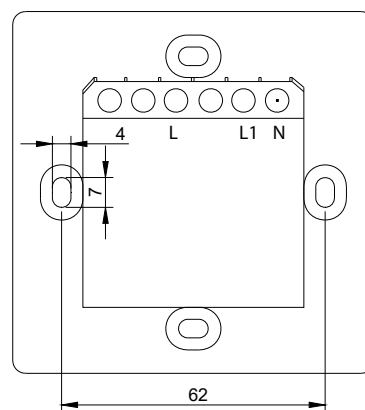
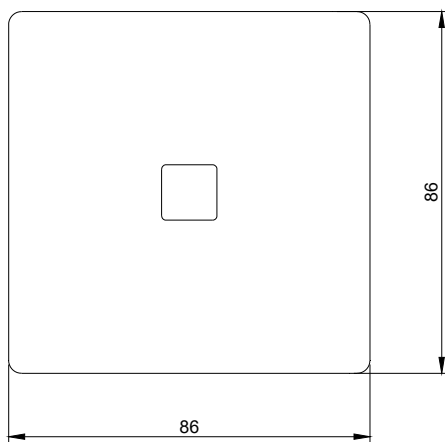

Schaltplan:

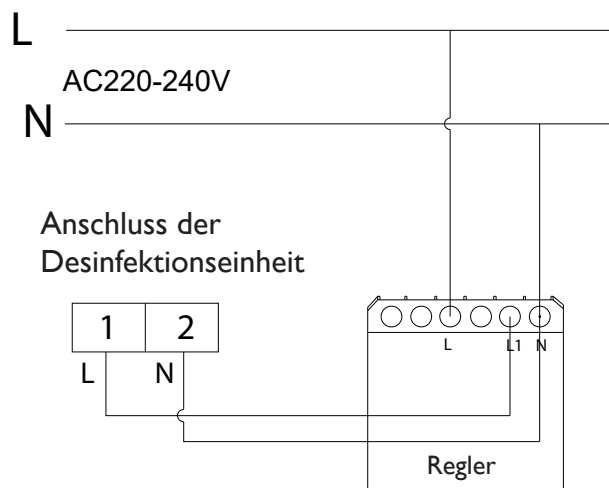

An "Ein/Aus-Controller" anschließen

BEDIENUNG

OPTIONAL (2): BEDIENUNGSPANEEL MIT KNOFF

Referenzfotos:



Geräte Abmessungen:

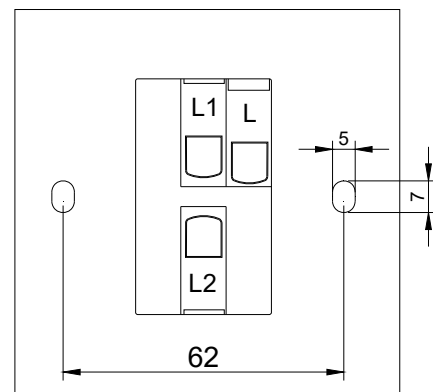
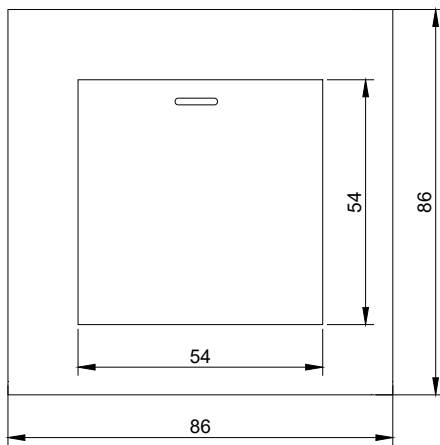

Schaltplan:

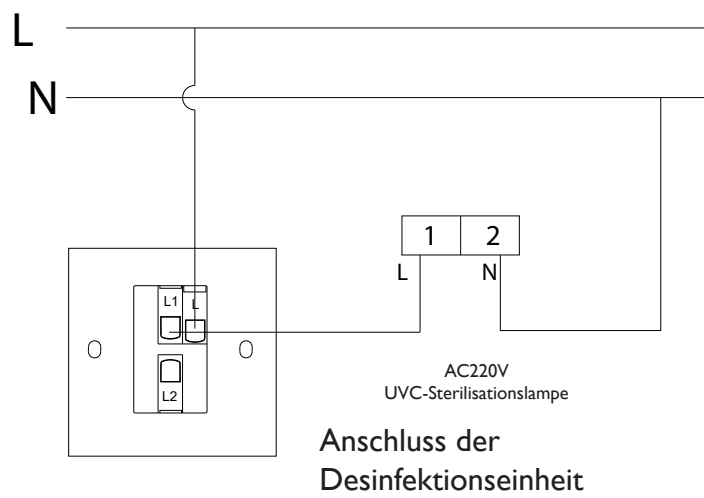

CONSIGNES DE SECURITE

Lisez les instructions de sécurité suivantes avant de commencer l'installation. Et assurez-vous que l'appareil est correctement installé. Suivez toutes les instructions pour éviter des blessures ou des dommages à l'équipement ou à la propriété. Les informations contenues dans ce document peuvent être modifiées sans préavis. La version la plus récente de ce manuel est toujours disponible sur www.markclimate.fr/downloads.

FR

Aspects de sécurité









Les symboles suivants indiquent les niveaux d'avertissement possibles.

 Warning	Situations présentant un risque de mort ou de blessures graves.	 Attention	Situations présentant un risque de blessure ou de dommage matériel / dommages matériels.
---	---	---	--









Les symboles suivants indiquent les instructions à suivre

	Pas autorisé ou arrêtez	 Suivi	 Obligatoire
---	-------------------------	---	---







Avertissement







	L'installation doit être effectuée par une personne qualifiée. Les utilisateurs finaux ne doivent pas installer, déplacer ou réinstaller cet équipement eux-mêmes.		Un filet anti-oiseaux ou un dispositif similaire doit être installé sur les événements extérieurs. Assurez-vous qu'il n'y a aucun obstacle sur ou dans les gaines.
	Les installateurs doivent suivre strictement ce manuel. Une mauvaise action peut présenter un risque pour la santé et réduire l'efficacité de l'appareil.		La ventilation de l'air frais doit être suffisamment éloignée de la sortie des fumées ou des zones où des fumées dangereuses sont présentes.
	L'unité doit être installée strictement selon ce manuel et montée sur une surface de support pour le poids de l'unité.		Le génie électrique doit être conforme aux réglementations nationales et au manuel, utiliser des câbles spéciaux. De mauvais câbles et une ingénierie inappropriée peuvent provoquer un choc électrique ou un incendie.
	L'unité et l'alimentation doivent être coupées pendant l'entretien ou la réparation. Sinon, un choc électrique pourrait se produire.		Le fil de terre ne peut pas être connecté au tuyau de gaz, au tuyau d'eau, à l'éclairage ou à la ligne téléphonique, etc. Une mise à la terre incorrecte peut provoquer un choc électrique.

Attention

	Le ou les câblages d'alimentation doivent être installés par un électricien qualifié. Une connexion incorrecte peut provoquer une surchauffe. Cela peut provoquer un incendie et une perte d'efficacité.		Pour éviter la condensation, une isolation doit être appliquée aux conduits d'air frais. D'autres gaines peuvent également nécessiter une isolation en fonction des conditions de point de rosée.
	Une isolation entre les gaines métalliques et le passage du mur doit être installée si la gaine pénètre dans le revêtement mural en métal pour éviter tout risque de choc électrique ou de courant de fuite.		Le couvercle du boîtier de câblage doit être enfoncé et fermé pour empêcher la poussière et la saleté de pénétrer. Une poussière et des saletés excessives peuvent surchauffer les bornes et provoquer un incendie ou un choc électrique.
	Utilisez uniquement du matériel d'installation et des accessoires approuvés. Le non-respect de cette consigne peut entraîner un risque d'incendie, un choc électrique et une défaillance de l'équipement.		Si l'unité est installée à un niveau élevé dans un environnement chaud et humide: assurer une ventilation adéquate.
	Les gaines extérieurs doivent être installés vers le bas pour empêcher l'eau de pluie de pénétrer. Une installation incorrecte peut provoquer une fuite d'eau.		Un MCB de dimensions correctes doit être appliqué à l'appareil. Une protection appropriée contre les fuites à la terre doit également être installée pour éviter tout risque de choc électrique ou d'incendie.

CONSIGNES DE SECURITE

 Attention	
 N'installez pas l'appareil dans des conditions extrêmement humides, car cela pourrait provoquer un choc électrique et créer un risque d'incendie.	 N'utilisez pas les unités comme extracteur de graisse pour la cuisine. Les dépôts de graisse peuvent bloquer l'échangeur de chaleur, le filtrer et présenter un risque d'incendie.
 N'installez pas l'appareil dans des zones où des gaz toxiques ou corrosifs sont présents.	 N'installez pas l'appareil près d'une flamme nue, car cela peut entraîner une surchauffe et un incendie.
 Les environnements acides ou alcalins peuvent provoquer un empoisonnement ou un incendie.	 La tension d'alimentation nominale doit être maintenue, sinon un incendie pourrait se produire.

 Warning	
 Cet appareil peut être utilisé par des enfants dès 8 ans et des personnes présentant des capacités physiques, sensorielles ou mentales réduites ou manquant d'expérience ou de connaissances, à condition qu'ils soient surveillés ou aient reçu des instructions pour utiliser l'appareil en toute sécurité et qu'ils en comprennent les risques.	
 Il est interdit aux enfants de jouer avec l'appareil.	 Le nettoyage et l'entretien de l'appareil ne peuvent être effectués par des enfants sans surveillance.
 Le matériel de déconnexion doit être intégré dans le réseau de câbles conformément aux règles en matière de câblage.	 Il y a lieu de débrancher l'appareil du réseau électrique avant son nettoyage ou un autre type d'entretien.

SPECIFICATIONS

Modèle	MDU 500	MDU 1000
Débit d'air (m ³ /h)	400~600	600~1300
Pression externe (Pa)	5	5
Tension d'alimentation (V)	230	230
Puissance d'entrée (W)	6	7.4
Poids (kg)	6	7.8

DIMENSIONS

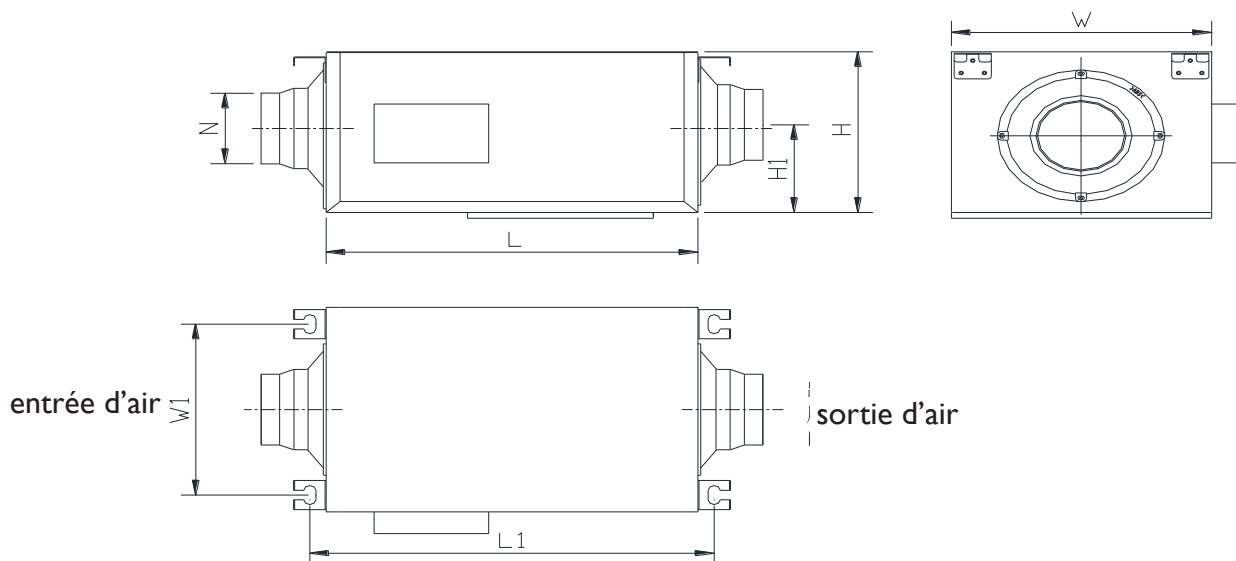

FR

Modèle	L	L1	W	WI	H	HI	N
MDU 500	400	433	320	282	290	145	198
MDU 1000	400	433	350	291	310	155	242

INSTALLATION

1. Installé dans le conduit d'air en connexion en série, en combinaison avec d'autres appareils de ventilation (tels qu'un ventilateur d'air frais, un boîtier de purification d'air, etc.).
2. Indépendamment des éventuels motifs de retard d'installation du boîtier de désinfection et de son stockage à court ou à long terme sur le chantier, des mesures de protection doivent être prises afin d'éviter que des poussières ou des graviers de construction ne pénètrent dans l'appareil.
3. Ne pas installer l'appareil à proximité d'un chauffe-eau.
4. Les phénomènes suivants doivent être évités dans le projet d'installation des conduites.

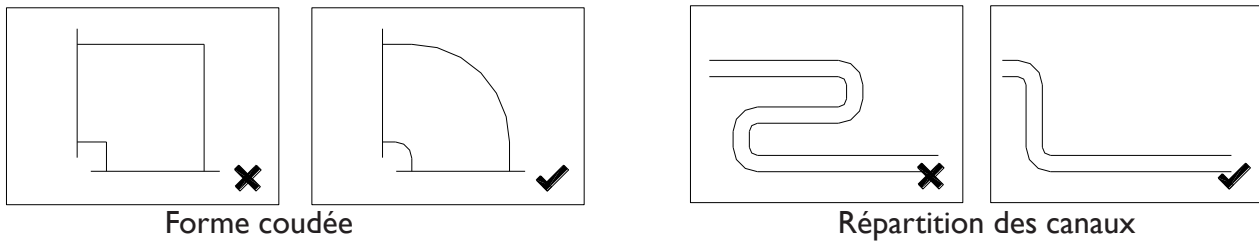

5. Lieu d'installation : L'appareillage est relié à d'autres équipements de ventilation par des conduits d'air et aucune amenée d'air ou entrée de retour d'air ne peut être installée entre les deux appareils.
6. Raccordement du conduit d'air : Lorsque le diamètre du conduit ne correspond pas au diamètre du conduit d'air du système de ventilation, utilisez le réducteur de conduit pour le raccordement intermédiaire. Le raccord entre plusieurs diamètres de conduites doit satisfaire aux spécifications de conception des conduits de ventilation (à savoir $< 15^\circ$ de chaque côté).
7. Adaptation du volume d'air : Les valves d'air pour adapter le volume d'air doivent être installées dans le conduit principal, afin que chaque ventilateur faisant partie du système de ventilation ne fonctionne pas en cas de surcharge. Plus le volume d'air est élevé, plus le système de désinfection est surchargé.
8. Il est conseillé d'utiliser l'appareillage de ventilation avec des filtres primaires et des filtres F9 pour fonctionner conjointement avec le boîtier de désinfection, afin d'obtenir un meilleur résultat.

INSTALLATION ÉLECTRIQUE



Avertissement

L'alimentation doit être coupée pendant l'installation et avant l'entretien pour éviter les blessures par choc électrique. Les spécifications des câbles doivent répondre strictement aux exigences, sinon cela peut entraîner une baisse des performances et provoquer un choc électrique ou un incendie.

FR

L'alimentation est de phase AC220V / 50HZ / I.



Avertissement

Nous déclinons toute responsabilité pour tout problème causé par la réingénierie propre et non autorisée de l'utilisateur des systèmes électriques et de contrôle.

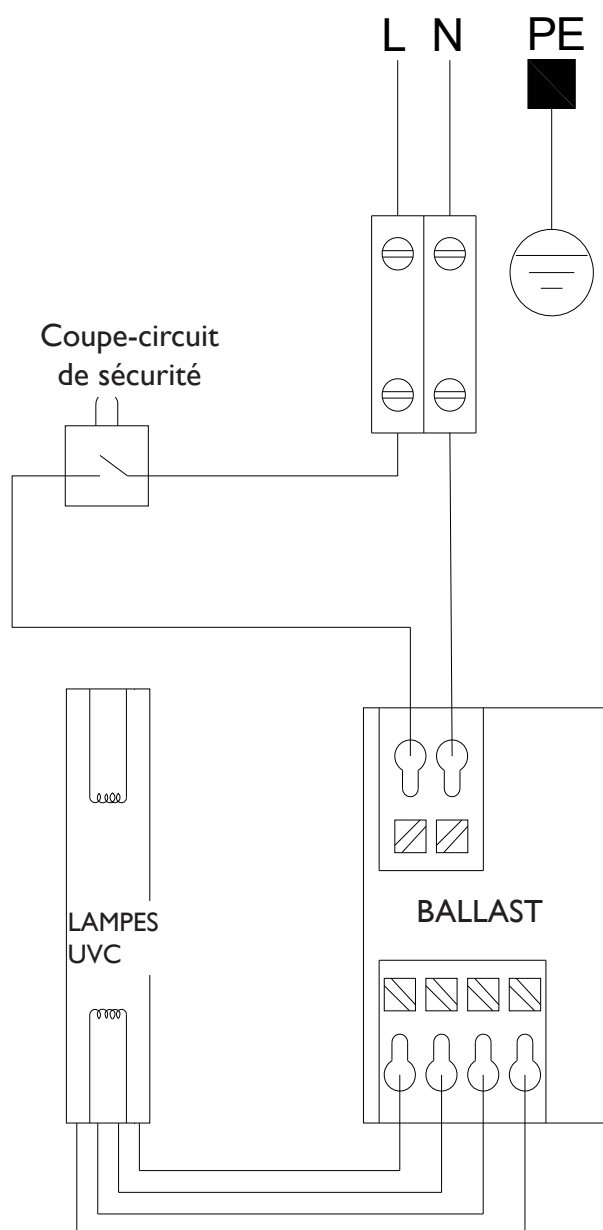

INSTALLATION ÉLECTRIQUE

MISE EN SERVICE

Lorsque le projet d'installation est terminé, respectez les étapes suivantes pour la mise en service (laissez cette tâche à un professionnel).

1. Vérifiez d'abord si le câblage de l'appareillage et l'alimentation électrique sont bons, afin de vous assurer que tout le câblage est réalisé correctement avant la mise en service.
2. Utilisez un multimètre pour mesurer l'alimentation électrique et vérifier si elle est normale.
3. En cas d'anomalies de fonctionnement pendant la mise en service, débranchez immédiatement l'appareil, coupez l'alimentation électrique principale et revérifiez tout, afin d'éviter tout choc électrique.

CARACTÉRISTIQUES

La lumière ultraviolette associée à un filtre photocatalyseur peut stimuler la réaction de substances chimiques et utiliser l'énergie lumineuse pour la convertir en énergie nécessaire pour engendrer une réaction chimique de manière à exciter les molécules d'oxygène et les molécules d'eau en ions négatifs OH et O₂ oxydatifs libres, capables de décomposer des gaz nocifs tels que le benzène, le formaldéhyde, etc., qui détruisent la structure moléculaire de l'ADN et de l'ARN dans les cellules des micro-organismes en leur faisant perdre leur capacité de se reproduire et tuent les cellules en pleine croissance en aboutissant ainsi à l'objectif de stérilisation et de désinfection et les transforment en dioxyde de carbone et en eau inoffensifs.

MESURES DE PRÉCAUTION

1. Lors de l'entretien de l'appareil, coupez le courant avant d'ouvrir le couvercle d'inspection et procédez ensuite seulement aux opérations d'entretien et d'inspection.
2. Portez des gants pendant l'entretien ou toute réparation, afin d'éviter des lésions.
3. Pendant l'entretien, fixez l'échelle afin d'éviter les chutes.

INSTRUCTIONS D'INSTALLATION

(I) INSTALLATION AVEC UN VENTILATEUR À RÉCUPÉRATION D'ÉNERGIE

- 1, Le boîtier de désinfection d'air frais peut être utilisé en combinaison avec un ventilateur à récupération d'énergie. Il fonctionne conjointement avec un dispositif de verrouillage.
- 2, Le boîtier de désinfection d'air frais est en mesure de stériliser l'air extérieur et l'air intérieur.
- 3, Il est conseillé de mettre d'abord en place un boîtier de désinfection d'air frais sur les circuits d'amenée et d'évacuation d'air.
- 4, Les deux extrémités du boîtier de désinfection d'air frais doivent être raccordées sur la conduite principale au moyen de flexibles.

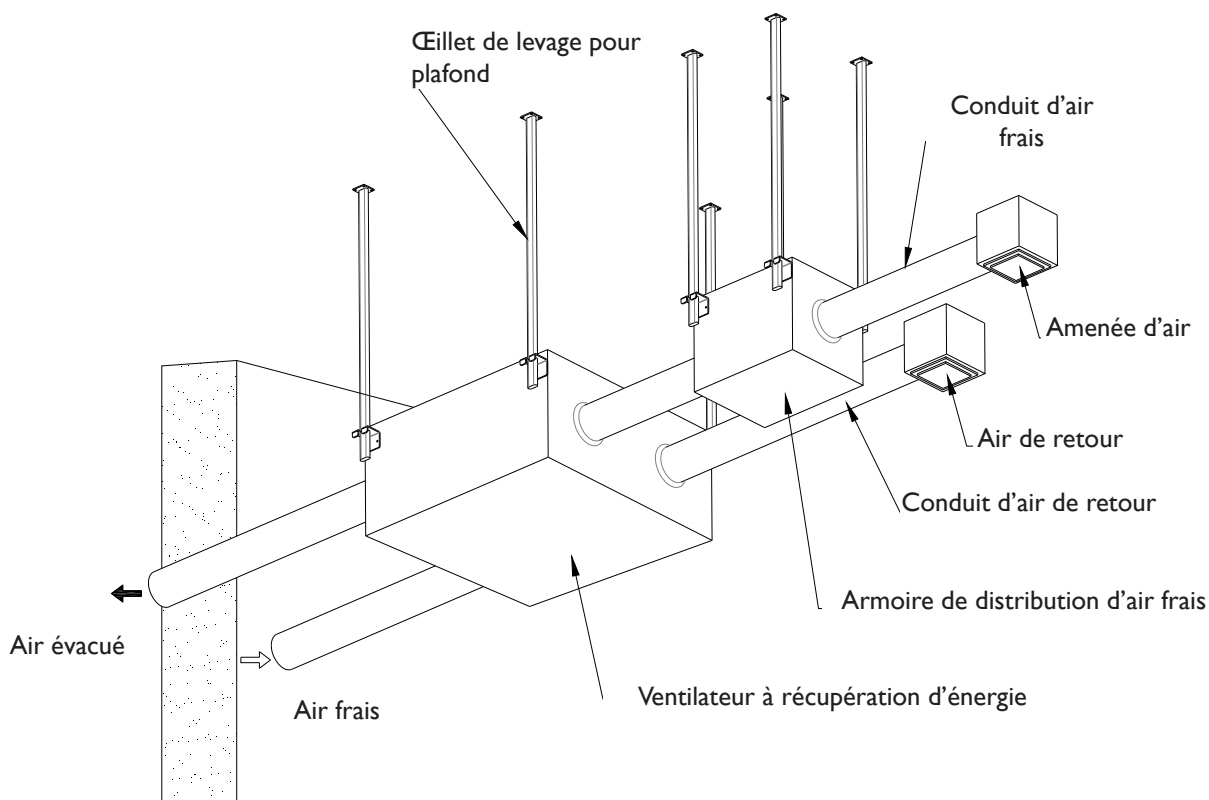

INSTRUCTIONS D'INSTALLATION

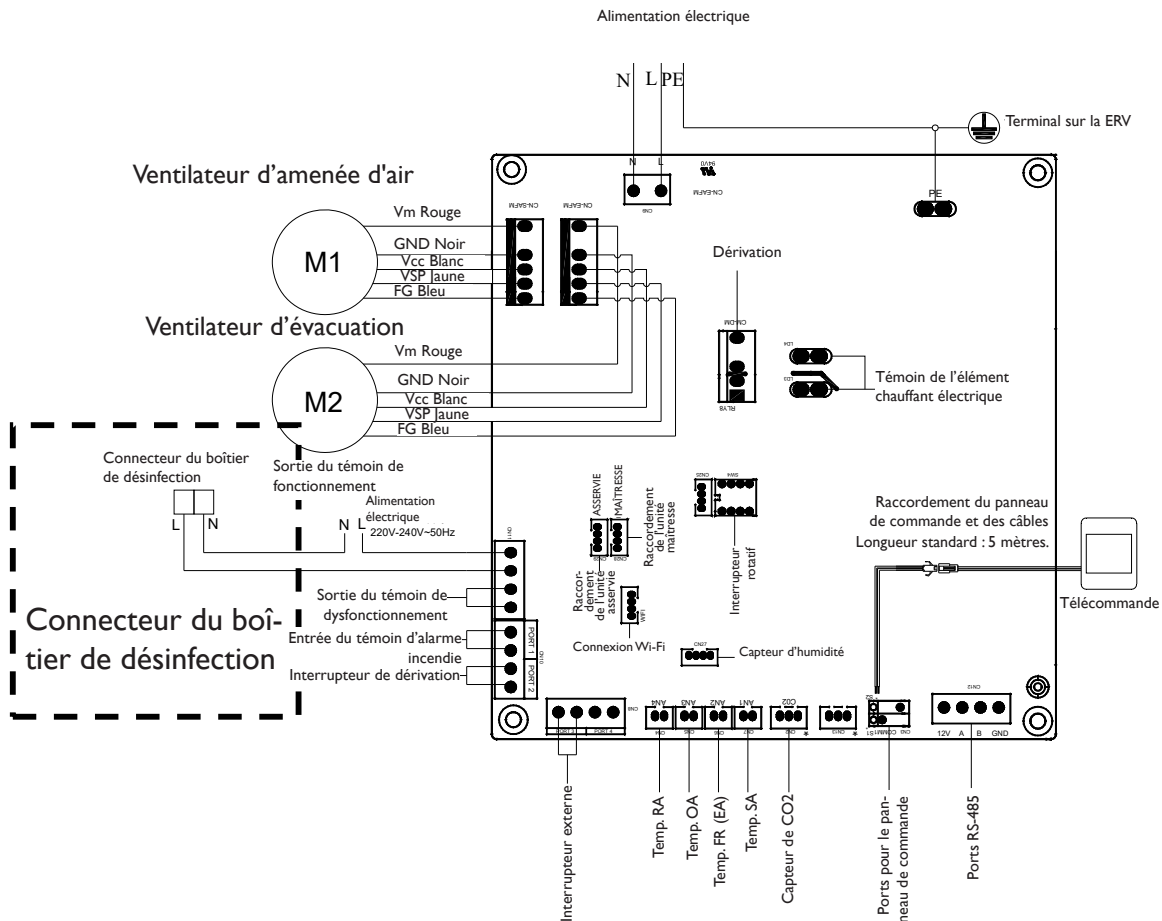

Raccordement au contrôleur ERV (Type de moteur en C.C.)

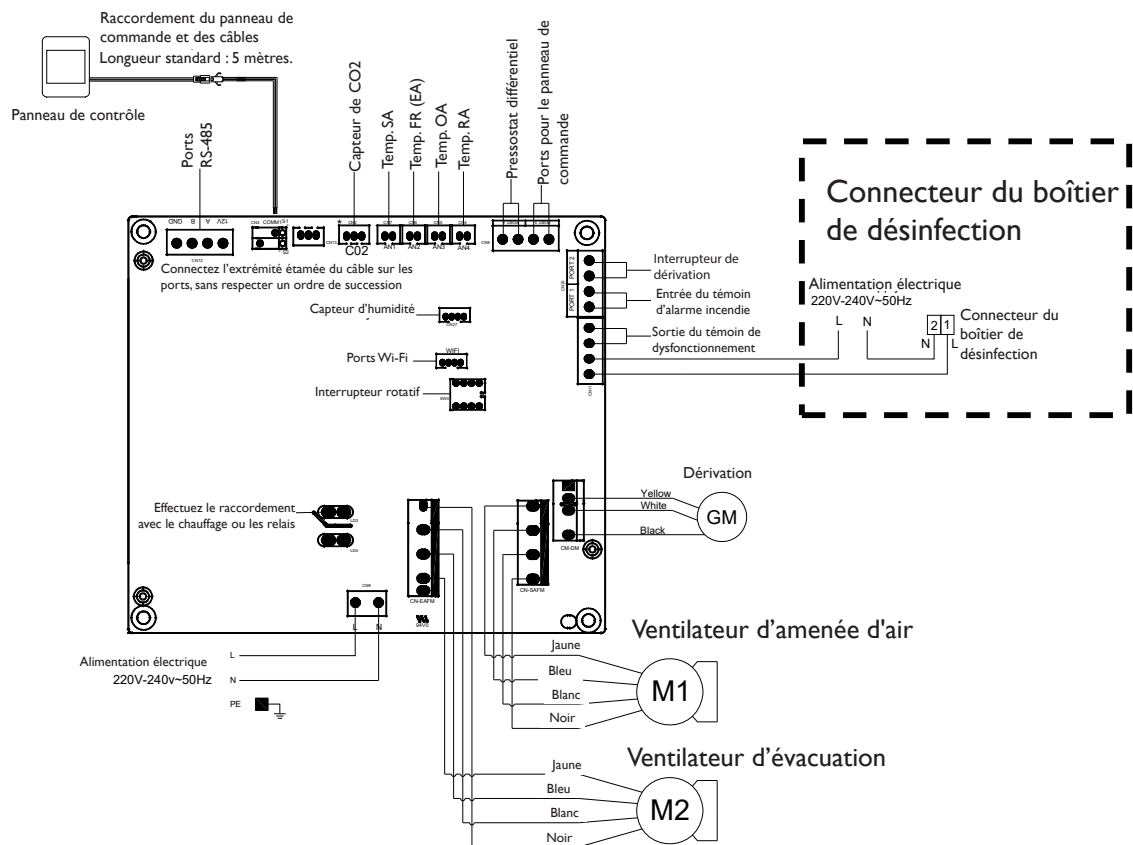

Raccordement au contrôleur ERV (Type de moteur AC)

INSTRUCTIONS D'INSTALLATION

(2) INSTALLATION AVEC UN BOÎTIER DE FILTRATION D'AIR FRAIS

- 1, Le boîtier de désinfection d'air frais peut être utilisé en combinaison avec le boîtier de filtration d'air frais, qui peuvent fonctionner conjointement avec un dispositif de verrouillage.
- 2, Le boîtier de désinfection d'air frais est en mesure de stériliser l'air extérieur et l'air intérieur.
- 3, Il est conseillé d'installer le boîtier de désinfection d'air frais après le boîtier de filtration.
- 4, Les deux extrémités du boîtier de désinfection d'air frais doivent être raccordées sur la conduite principale au moyen de flexibles.

FR

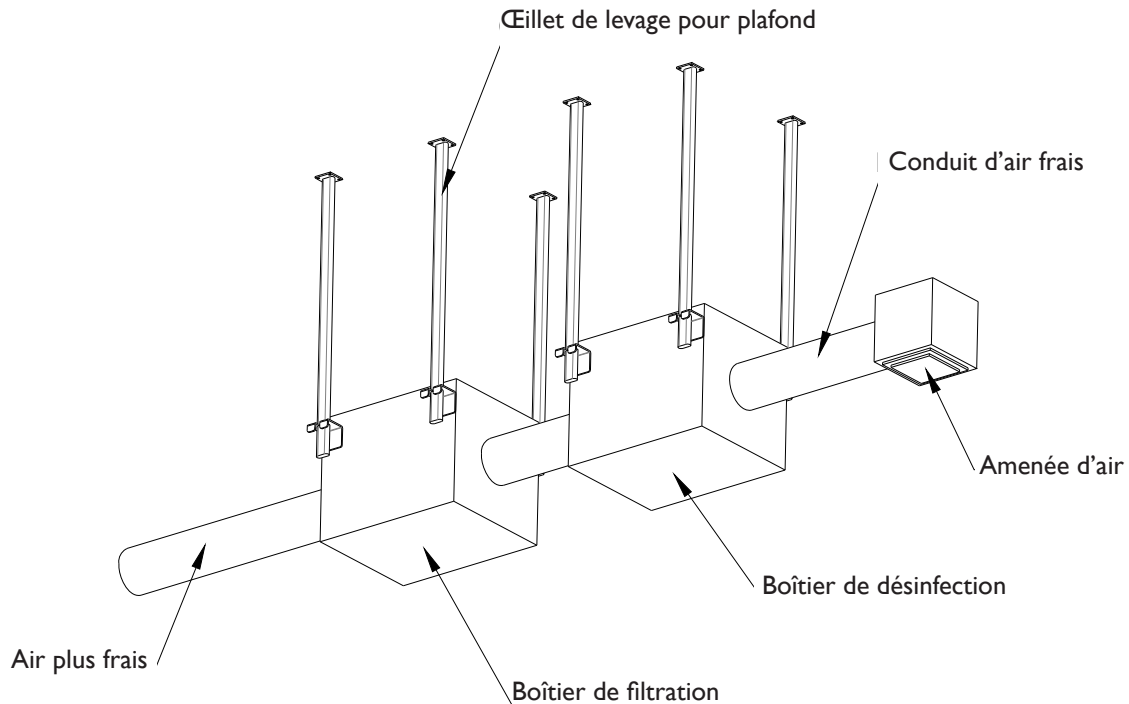

Boîtier de filtration d'air frais avec bouton de commande :

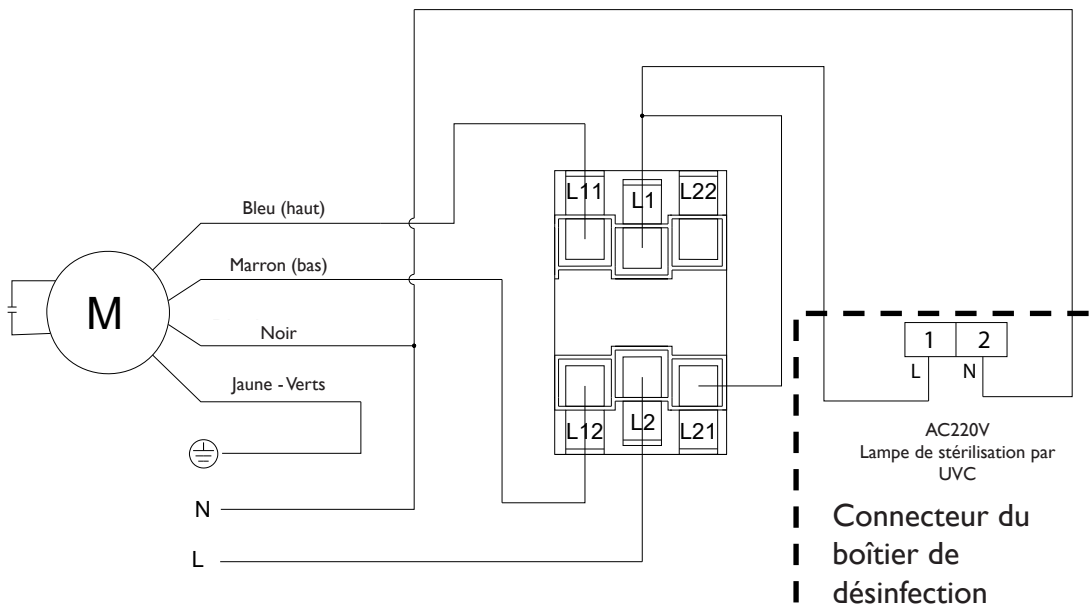

COMMANDE

COMMANDE INDÉPENDANTE

- 1, Le boîtier de désinfection peut être utilisé de manière indépendante au moyen d'un contrôleur ON/OFF.
- 2, Le boîtier de désinfection est en mesure de stériliser l'air pollué intérieur et extérieur.
- 3, Il est conseillé de placer le boîtier de désinfection derrière le ventilateur ou le souffleur.
- 4, Les deux extrémités du boîtier de désinfection doivent être raccordées sur la conduite principale au moyen de flexibles.

EN OPTION (I) : PANNEAU DE COMMANDE À TOUCHES TACTILES

Photo de référence :



Dimensions d'installation :



Schéma électrique :



Raccordement au contrôleur ON/OFF

COMMANDE

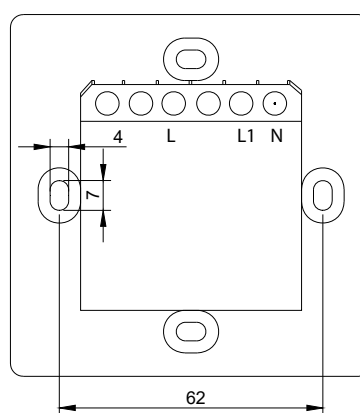
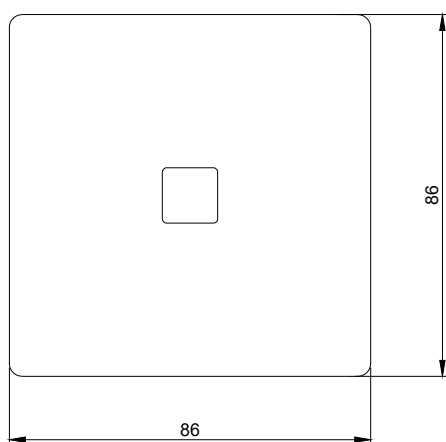
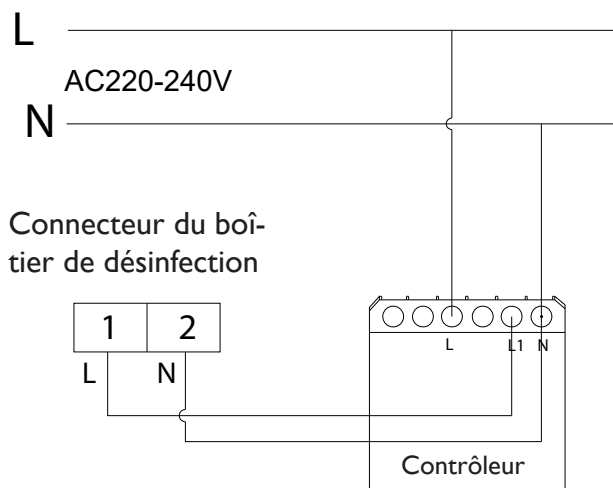
EN OPTION (2) : PANNEAU DE COMMANDE À BOUTON

Photo de référence :



FR

Dimensions d'installation :











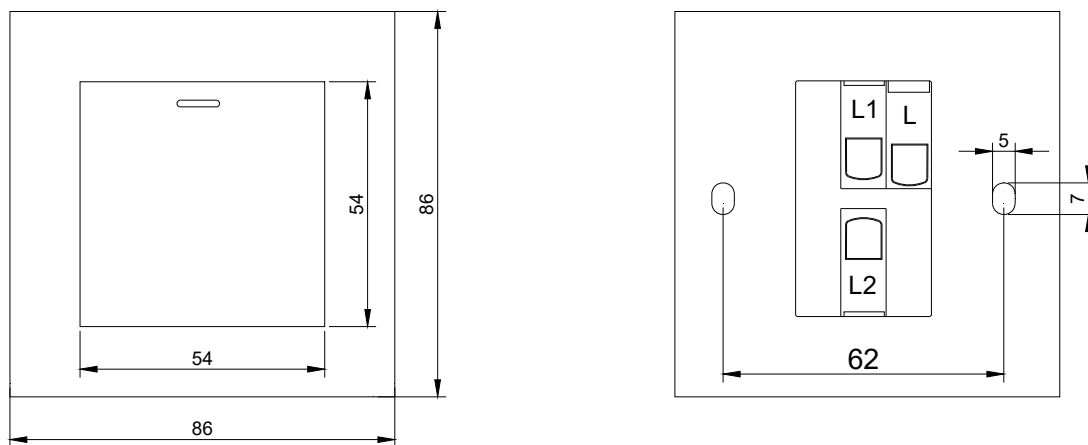
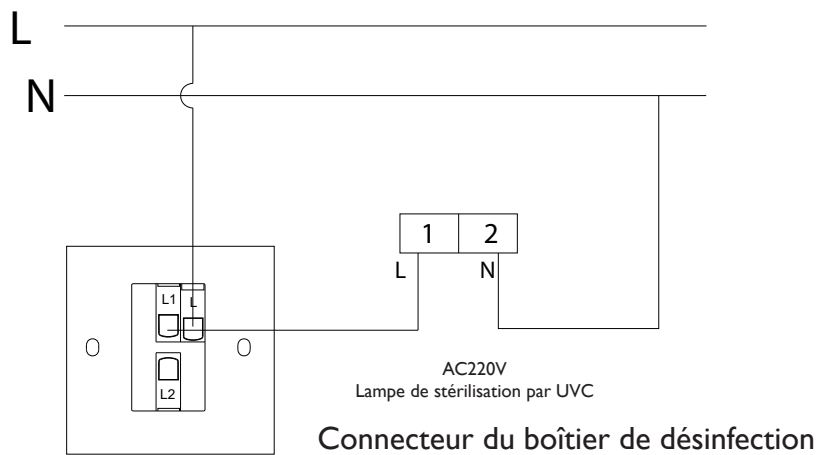















Schéma électrique :









VEILIGHEIDSINSTRUCTIES







Lees de volgende veiligheidsinstructies voordat u met de installatie begint. En zorg ervoor dat het apparaat correct is geïnstalleerd. Neem alle instructies in acht om letsel of schade aan apparatuur of eigendommen te voorkomen. De informatie in dit document kan zonder voorafgaande kennisgeving worden gewijzigd. De meest recente versie van deze handleiding is altijd beschikbaar op www.mark.nl/downloads.

Veiligheidsaspecten			
De volgende symbolen geven mogelijke waarschuwningsniveaus aan.			
 Warning	Situaties met een risico op overlijden of ernstig letsel.	 Attention	Situaties met risico op letsel of materiële / materiële schade.
De volgende symbolen duiden op instructies die moeten worden nageleefd			
	Niet toegestaan of stoppen	 Opvolgen	 Verplicht
 Waarschuwing			
	Installatie moet worden uitgevoerd door een gekwalificeerd persoon. Eindgebruikers mogen deze apparatuur niet zelf installeren, verplaatsen of opnieuw installeren.		Een anti-vogelnet of een soortgelijk apparaat moet worden geïnstalleerd op de buitenste ventilatieopeningen. Zorg ervoor dat er geen obstakels zijn naar of in de kanalen.
	Installateurs moeten deze handleiding strikt opvolgen. Onjuiste actie kan een gevaar voor de gezondheid opleveren en de efficiëntie van het apparaat verminderen.		Ventilatie van verse lucht moet ver genoeg verwijderd zijn van rookgasafvoer of gebieden waar gevaarlijke dampen aanwezig zijn.
	De unit moet strikt worden geïnstalleerd volgens deze handleiding en op een draagvlak voor het gewicht van het apparaat worden gemonteerd.		Elektrotechniek moet voldoen aan de nationale voorschriften en de handleiding, gebruik speciale kabels. Slechte kabels en onjuiste engineering kunnen een elektrische schok of brand veroorzaken.
	Tijdens onderhoud of reparatie moeten de unit en de voeding zijn uitgeschakeld. Anders kan een elektrische schok optreden.		Aarddraad kan niet worden aangesloten op gasleiding, waterleiding, verlichting of telefoonlijn, enz. Onjuiste aarding kan een elektrische schok veroorzaken.
 Attentie			
	Voedingskabel(s) moeten worden geïnstalleerd door een gekwalificeerde elektrotechnicus. Onjuiste aansluiting kan oververhitting veroorzaken. Dit kan vuur en verlies van efficiëntie veroorzaken.		Om condensatie te voorkomen, moet isolatie worden aangebracht op luchtkanalen voor verse lucht. Andere kanalen kunnen ook isolatie vereisen afhankelijk van de omstandigheden van het dauwpunt.
	Isolatie tussen de metalen kanalen en de muurdoorvoer moet worden geïnstalleerd indien de buis door metalen wandbekleding dringt om het risico van een elektrische schok of lekstroom te voorkomen.		Het deksel van de bedradingsdoos moet worden ingedrukt en gesloten om te voorkomen dat er stof en vuil in komt. Overmatig stof en vuil kan oververhitting van de aansluitingen veroorzaken en resulteren in brand of een elektrische schok.
	Gebruik alleen goedgekeurde installatiehardware en -accessoires. Het niet in acht nemen kan leiden tot brandgevaar, elektrische schokken en uitval van apparatuur.		Indien de unit is geplaatst, op hoog niveau in een warme, vochtige omgeving: zorg voor voldoende ventilatie.
	De buitenkanalen moeten naar beneden worden geïnstalleerd om te voorkomen dat regenwater binnendringt. Onjuiste installatie kan waterlekage veroorzaken.		MCB met de juiste afmetingen moeten op het apparaat worden aangebracht. Er moet ook een geschikte aardlekbeveiliging worden geïnstalleerd om het risico van een elektrische schok of brand te voorkomen.

VEILIGHEIDSINSTRUCTIES

 Attentie	
 Installeer het apparaat niet in extreem vochtige omstandigheden, dit kan een elektrische schok veroorzaken en brandgevaar opleveren.	 Gebruik de units niet als vetafzuiging voor in de keuken. Vetafzetting kan de warmtewisselaar blokkeren, filteren en een brandgevaar opleveren.
 Installeer het apparaat niet in gebieden waar giftige of bijtende gassen aanwezig zijn.	 Installeer het apparaat niet in de buurt van open vuur, omdat dit kan leiden tot oververhitting en brandgevaar.
 Zure of alkalische omgevingen kunnen vergiftiging of brand veroorzaken.	 Nominale voedingsspanning moet worden aangehouden, anders kan er brand veroorzaakt worden.

NL

 Warning	
 Dit apparaat kan worden gebruikt door kinderen van 8 jaar en ouder en personen met verminderde fysieke, sensorische of mentale vermogens of gebrek aan ervaring en kennis, mits ze onder toezicht staan of instructies hebben gekregen over het veilige gebruik van het apparaat en ze de gevaren begrijpen.	
 Kinderen mogen niet met het apparaat spelen.	 Reiniging en gebruikersonderhoud mogen niet zonder toezicht door kinderen worden uitgevoerd.
 Middelen voor ont koppeling moeten in de vaste bedrading worden opgenomen in overeenstemming met de bedradingsregels	 Voorafgaand aan reiniging of ander onderhoud moet het apparaat worden losgekoppeld van het elektriciteitsnet.

SPECIFICATIES

Model	MDU 500	MDU 1000
Luchtstroom (m ³ /h)	400~600	600~1300
Externe druk (Pa)	5	5
Voltage (V)	230	230
Ingangsvermogen (W)	6	7.4
Gewicht (Kg)	6	7.8

DIMENSIES

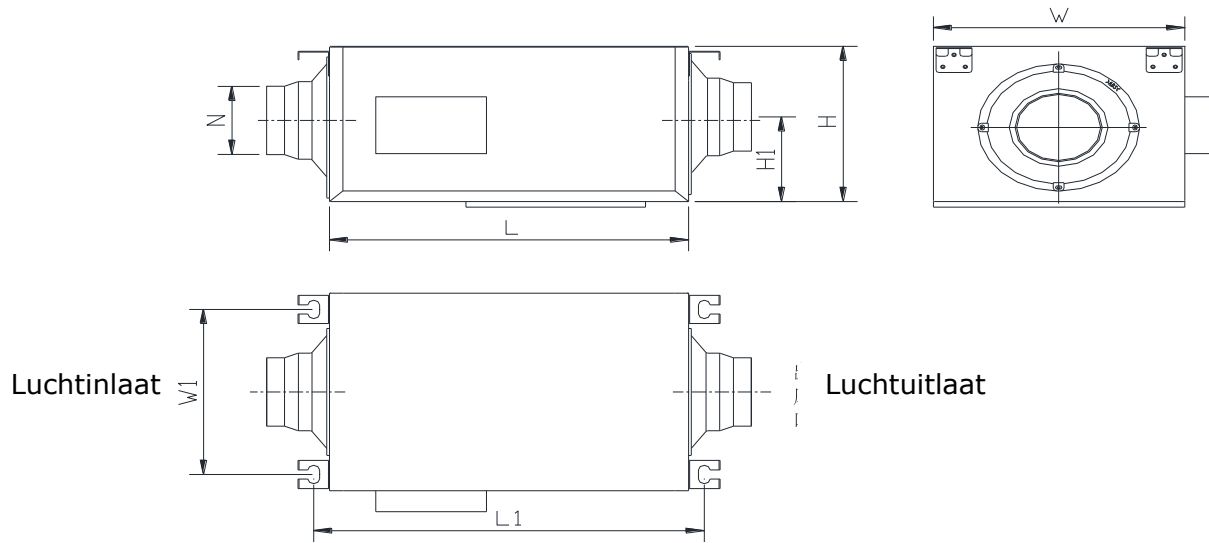

Model	L	LI	W	WI	H	HI	N
MDU 500	400	433	320	282	290	145	198
MDU 1000	400	433	350	291	310	155	242

INSTALLATIE

1. Geïnstalleerd in het luchtkanaal in serieschakeling en gebruikt in combinatie met andere ventilatie apparatuur (zoals verseluchtventilator, luchtzuiveringsbox, etc.).
2. Ongeacht de eventuele reden voor het vertragen van de installatie van de desinfectiebox en de kortstondige of langdurige opslag van de desinfectiebox op de werf, moeten passende beschermen de maatregelen worden genomen om te voorkomen dat bouwstof en grind de machine binnendringen.
3. Niet installeren in de buurt van de boiler.
4. De volgende verschijnselen moeten worden vermeden in het installatiepijpleidingproject

NL

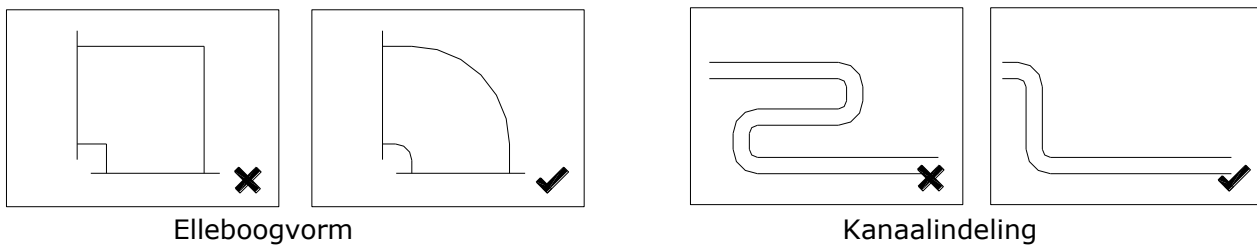

5. Installatielocatie: De apparatuur is via luchtleidingen verbonden met andere ventilatieapparatuur en er mag geen luchttoevoer- of retourluchtinlaat tussen de twee apparatuur worden geïnstalleerd.
6. Aansluiting luchtkanaal: Als de diameter van de kanaaldiameter niet overeenkomt met de diameter van het luchtkanaal van het ventilatiesysteem, gebruik dan de kanaalverkleiner voor de overgangs aansluiting. De verbinding tussen verschillende buisdiameters moet voldoen aan de ontwerpspecificaties van ventilatiekanalen (dwz minder dan 15° aan beide zijden)
7. Aanpassing van het luchtvolume: De luchtkleppen moeten in het hoofdkanaal worden geïnstalleerd om het luchtvolume aan te passen, zodat elke ventilator in het ventilatiesysteem niet bij overbelasting werkt. Hoe hoger het luchtvolume, hoe zwaarder de desinfectie wordt belast.
8. Het wordt aanbevolen om de ventilatieapparatuur met primaire filters en F9-filters te gebruiken om samen met de desinfectiebox te werken voor een beter desinfectie-effect.

ELEKTRISCHE INSTALLATIE



Waarschuwing

De stroom moet tijdens de installatie en vóór het onderhoud worden uitgeschakeld om letsel door een elektrische schok te voorkomen. De specificaties van kabels moeten strikt aan de vereisten voldoen, anders kan dit leiden tot falen van de prestaties en gevaar voor een elektrische schok of brand veroorzaken.

Voeding is AC220V / 50HZ / 1-fase.



Waarschuwing

Wij aanvaarden geen enkele aansprakelijkheid voor eventuele problemen veroorzaakt door eigen en niet-geautoriseerde re-engineering van de gebruiker ten opzichte van de elektrische en besturingssystemen.

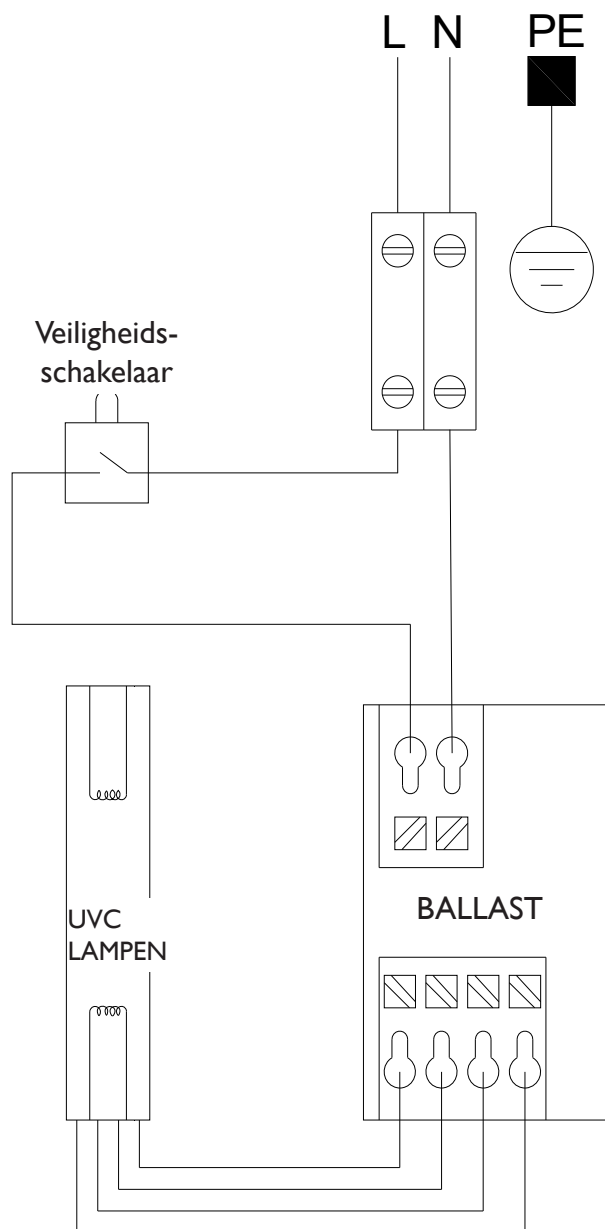

ELEKTRISCHE INSTALLATIE

INBEDRIJFSTELLING

Nadat het installatieproject is voltooid, volgt u de volgende stappen voor de inbedrijfstelling (laat dit uitvoeren door een vakman).

1. Controleer eerst of de bedrading van de apparatuur en de stroomtoevoer correct zijn, om er zeker van te zijn dat alle bedrading correct is voor de inbedrijfstelling.
2. Gebruik een multimeter om te meten of de stroomvoorziening normaal is.
3. Als er zich iets abnormaals voordoet tijdens de inbedrijfstelling, om elektrische schokken te voorkomen, dient u de apparatuur onmiddellijk uit te schakelen, de hoofdstroomtoevoer uit te schakelen en opnieuw te controleren.

NL

KENMERKEN

Ultraviolet licht + fotokatalysatorfilter kan de reactie van chemische stoffen bevorderen en lichtenergie gebruiken om om te zetten in energie die nodig is voor chemische reactie, zodat zuurstof- en watermoleculen kunnen worden geëxciteerd tot oxidatieve OH- en O₂-vrije negatieve ionen die het schadelijke gas zoals benzeen, formaldehyde, enz. kunnen ontleden, en de moleculaire structuur van DNA en RNA in de cellen van micro-organismen vernietigen, zodat ze het vermogen tot voortplanting verliezen, en de groeiende cellen doden, het doel bereiken van sterilisatie en desinfectie en ze omzetten in onschadelijk kooldioxide en water.

VOORZORGSMATREGELEN

1. Schakel tijdens het onderhoud, voordat u het inspectiedeksel opent, de stroom uit en voer vervolgens onderhoud en inspectie uit.
2. Draag handschoenen tijdens het onderhoud en de reparatie om letsel te voorkomen.
3. Bevestig tijdens het onderhoud de ladder om vallen te voorkomen.

INSTALLATIE INSTRUCTIES

(I) INSTALLATIE MET ENERGIETERUGWINNING VENTILATOR

- 1, De desinfectiebox voor verse lucht kan worden gebruikt in combinatie met een ventilator voor energierugwinning en werkt samen met een vergrendelingsregeling.
- 2, De desinfectiebox voor verse lucht kan de vervuilde buiten- of binnenlucht steriliseren.
- 3, Het wordt aanbevolen om een desinfectiebox voor verse lucht eerst op de luchttoevoer- en afvoerkanalen te installeren.
- 4, Beide uiteinden van de desinfectiebox voor verse lucht moeten met slangen op de hoofdleiding worden aangesloten.

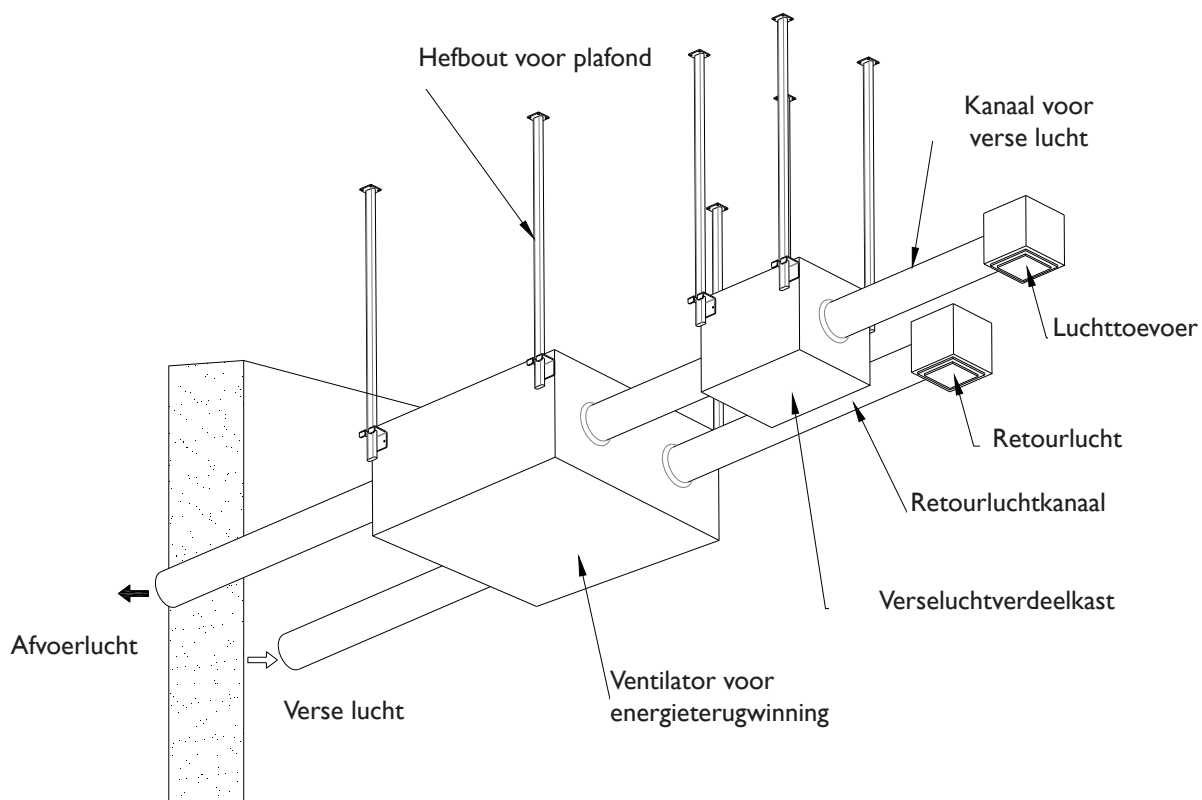

INSTALLATIE INSTRUCTIES

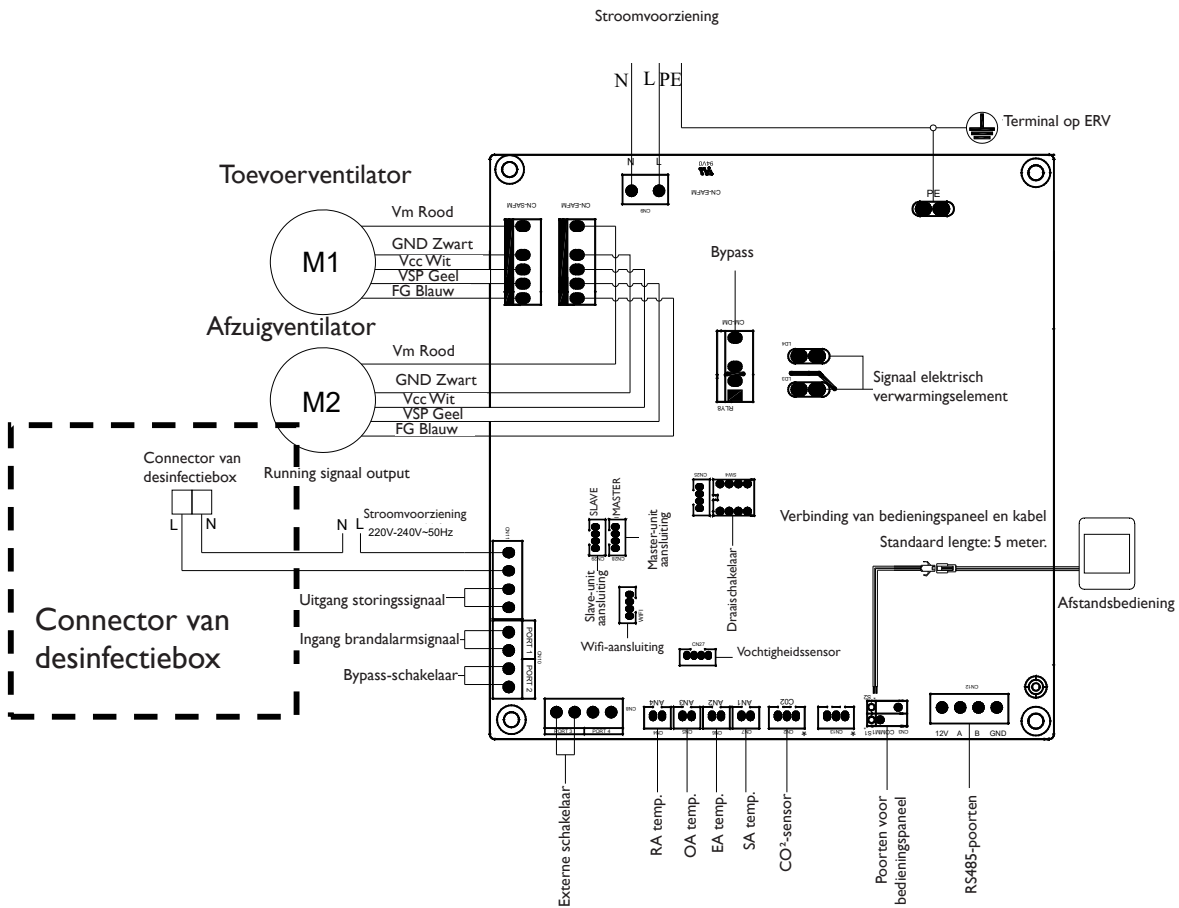

Koppeling met ERV-controller (DC motor type)

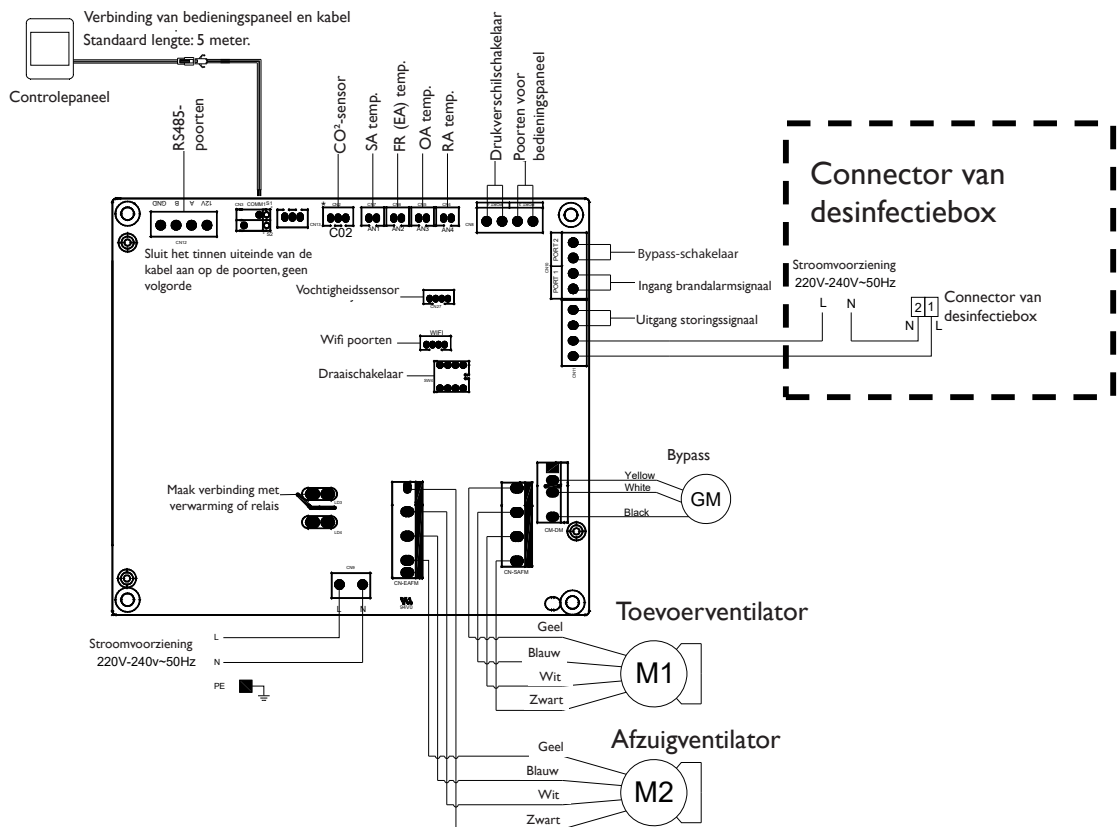

Koppeling met ERV-controller (AC motor type)

NL

INSTALLATIE INSTRUCTIES

(2) INSTALLATIE MET VERSE LUCHT FILTRATIE BOX

- 1, Verse lucht desinfectie box kan worden gebruikt in combinatie met verse lucht filtratie box, en samenwerken met interlock controle.
- 2, Verse lucht desinfectie box kan de vervuilde buiten- of binnenlucht steriliseren.
- 3, Verse lucht desinfectiebox wordt aanbevolen om te worden geïnstalleerd na de filtratiebox.
- 4, beide uiteinden van de desinfectiebox voor verse lucht moeten met slangen op de hoofdleiding worden aangesloten.

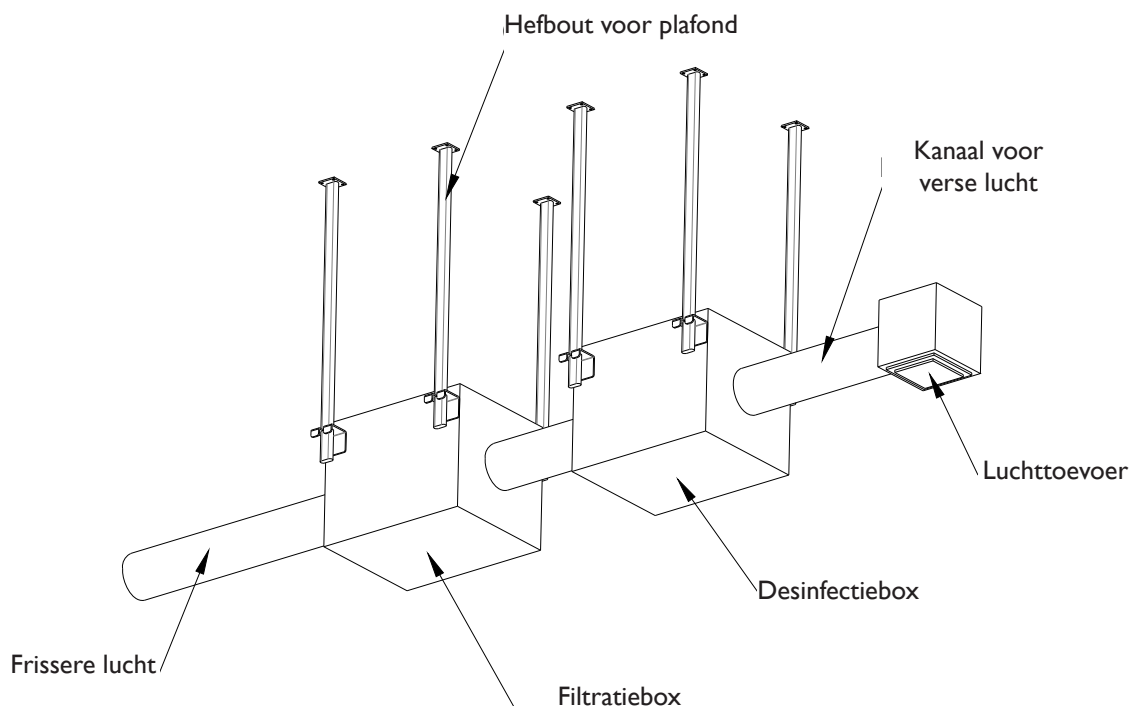

Frisse luchtfiltratiebox met bedieningsknop:

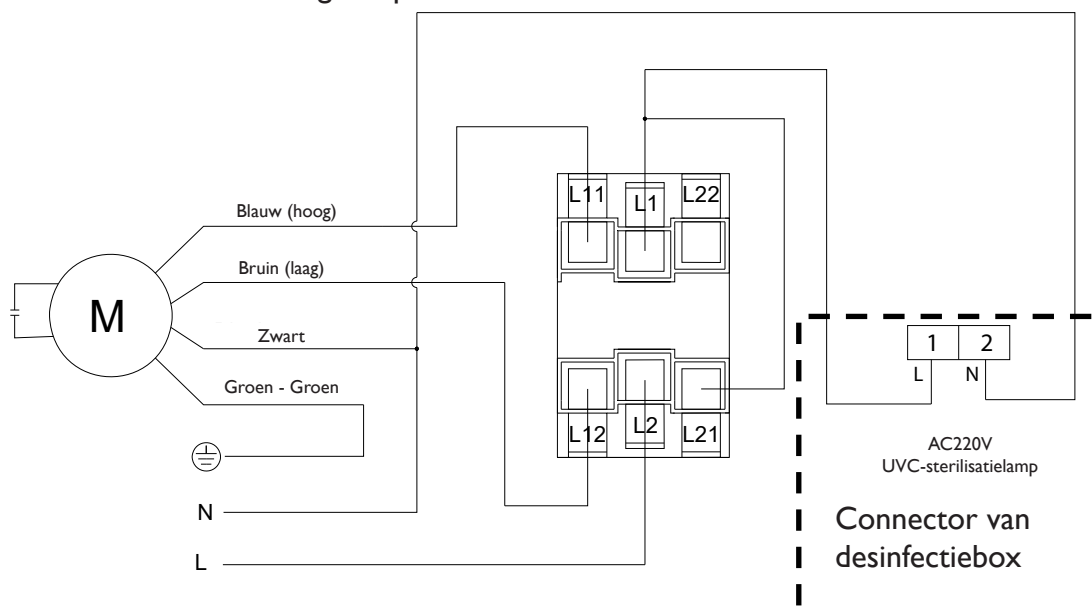

BEDIENING

ONAFHANKELIJKE BEDIENING

- 1, De desinfectiebox kan onafhankelijk worden gebruikt met een AAN / UIT-controller.
- 2, De desinfectiedoos kan de vervuilde lucht binnenshuis of buitenshuis steriliseren.
- 3, Het is aanbevolen om de desinfectiebox achter de ventilator of blazer te plaatsen.
- 4, Beide uiteinden van de desinfectiebox moeten met slangen op de hoofdleiding worden aangesloten.

OPTIONEEL (I): TOUCH SCREEN BEDIENINGSPANEEL

NL

Referentie foto:



Installatie afmetingen:

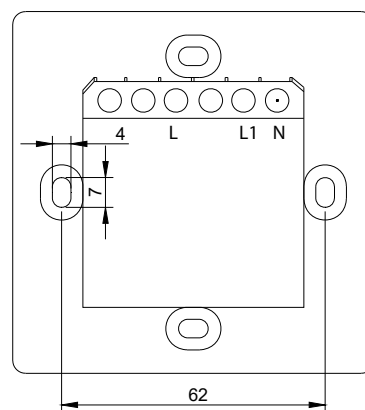
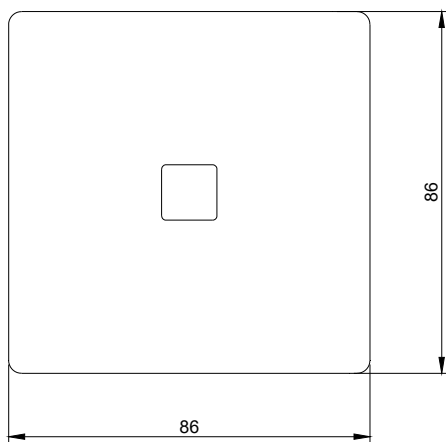

Schakelschema:

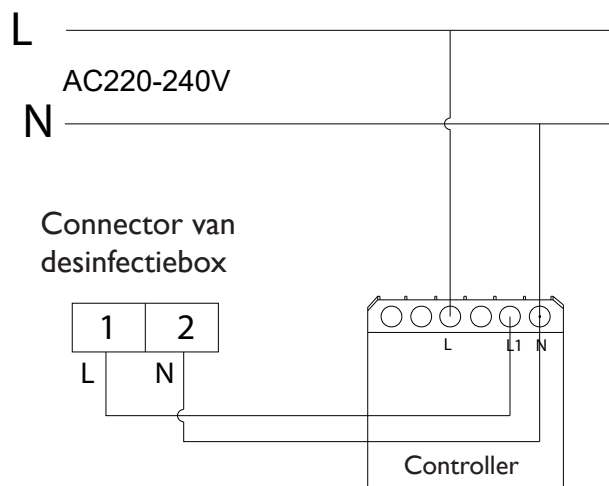

Maak verbinding met de aan / uit-controller

BEDIENING

OPTIONEEL (2): BEDIENINGSPANEEL MET KNOP

Referentie foto:



Installatie afmetingen:

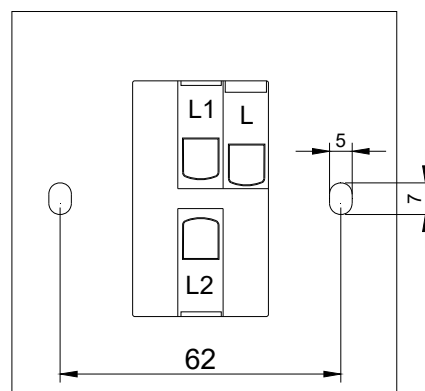
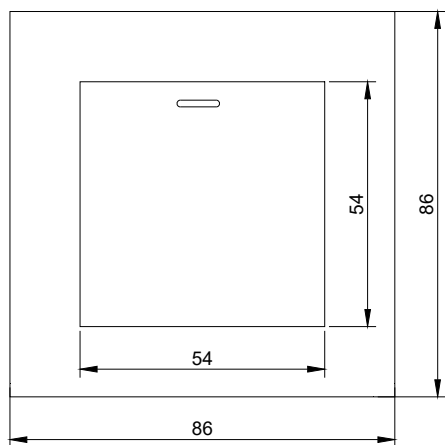



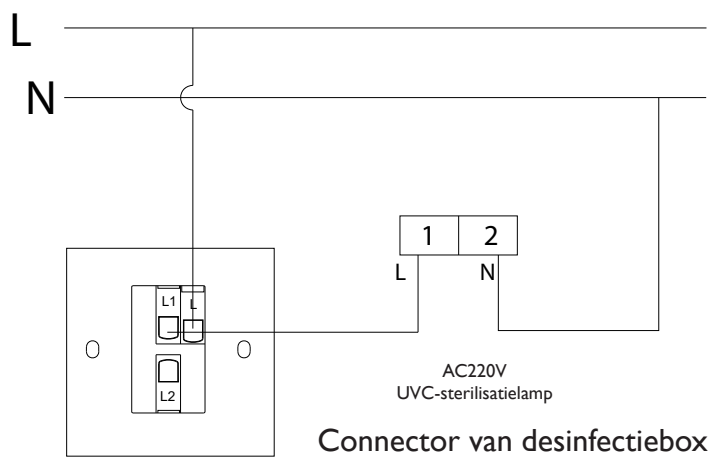



















Schakelschema:









SAFETY CONSIDERATIONS







Please read the following safety instructions before installation. And ensure that the unit is installed correctly. Please observe all instruction in order to avoid any injury or damage to equipment or property. The information in this document is subject to change without notice. The most recent version of this manual is always available at www.markclimate.com/downloads.

PL

Safety attentions			
The following symbols indicate potential levels of caution.			
 Warning	Situations with a risk or death or serious injure.	 Attention	Situations with a risk of injury or equipment/ property damage.
The following symbols indicate compliance which must be observed			
	Not allowed or Stop	 Must follow	 or obliged
 Warning			
	Installation to be carried out by qualified person, End Users must not install, move or re-install this equipment by themselves.		An anti-bird net or similar device should be installed to outside vents. Ensure there are no obstructions to or in the ducts.
	Installation engineers must follow this manual strictly. Improper action can create a health hazard and reduce efficiency of the unit.		Fresh air vent must be far enough away from any flue gas discharge or areas where hazardous vapors are present.
	Unit must be installed strictly following this manual and mounted to a weight bearing surface for the weight of the unit.		Electric engineering must follow national regulations and the manual, use special cables. Less capacity cables and improper engineering can cause electric shock or fire.
	During maintenance or repair, the unit and circuit breaker must be switched off. Other-wise electric shock could occur.		Ground wire cannot be connected to gas pipe, water pipe, lighting rod or telephone line etc. Incorrect grounding can cause electric shock.
 Attention			
	Power cable and wires must be installed by a qualified electrical engineer. Improper connection can cause over heating. Fire and loss of efficiency.		To avoid condensation, insulation should be fitted to fresh air ducts. Other ducting may also require insulation depending on dew point conditions.
	Insulation between the metal ducting and wall penetration must be installed if the ducting penetrates metal wall cladding, to avoid risk of electric shock or current leakage.		The cover of wiring box must be pressed down and closed to avoid dust and dirt entering. Excess dust and dirt can cause over-heating of terminals and result in fire or electric shock.
	Use only approved installation hardware and accessories. Failure to observe can result in fire risk, electric shock and equipment failure.		Where the unit is positioned, at high level in a hot humid situation. Please ensure sufficient ventilation is available.
	The outdoor ducts must be installed facing downwards to avoid rain water entering. Improper installation can cause water leakage.		Correctly sized MCB must be fitted to the unit suitable earth leakage protection should also be installed to avoid risk of electric shock or fire.

SAFETY CONSIDERATIONS

 Attention	
	Do not install the unit in an extremely humid conditions, as it may result in electric shock and pose a fire risk.
	Do not use the units as the primary kitchen extract grease and fatty deposits can block the heat exchanger, filter and pose a fire risk.
	Do not install the unit in areas there any poisonous or caustic gases are present.
	Do not install the unit near open flame as it may result in over heating and pose a fire risk.
	Acidic or alkali environments can cause poisoning or a fire.
	Rated supply voltage must be maintained, otherwise this may cause fire.

 Warning	
	To urządzenie może być używane przez dzieci w wieku od 8 lat i starsze oraz osoby o ograniczonych możliwościach fizycznych, sensorycznych lub umysłowych lub nieposiadające doświadczenia i wiedzy, jeśli są one pod nadzorem lub zostały poinstruowane w zakresie bezpiecznego korzystania z urządzenia i rozumieją związane z tym zagrożenia.
	Nie pozwól by dzieci bawiły się urządzeniem.
	Dzieci nie powinny przeprowadzać czyszczenia i konserwacji bez nadzoru.
	Zgodnie z przepisami dotyczącymi okablowania, stałe okablowanie musi uwzględniać odpowiednie elementy pozwalające na rozłączenie.
	Przed przystąpieniem do wykonywania czynności związanych z czyszczeniem lub konserwacją, urządzenie należy odłączyć od źródła zasilania.

SPECIFICATIONS

Model	MDU 500	MDU 1000
Air flow (m ³ /h)	400~600	600~1300
External pressure (Pa)	5	5
Voltage (V)	230	230
Input Power (W)	6	7.4
Weight (Kg)	6	7.8

DIMENSIONS

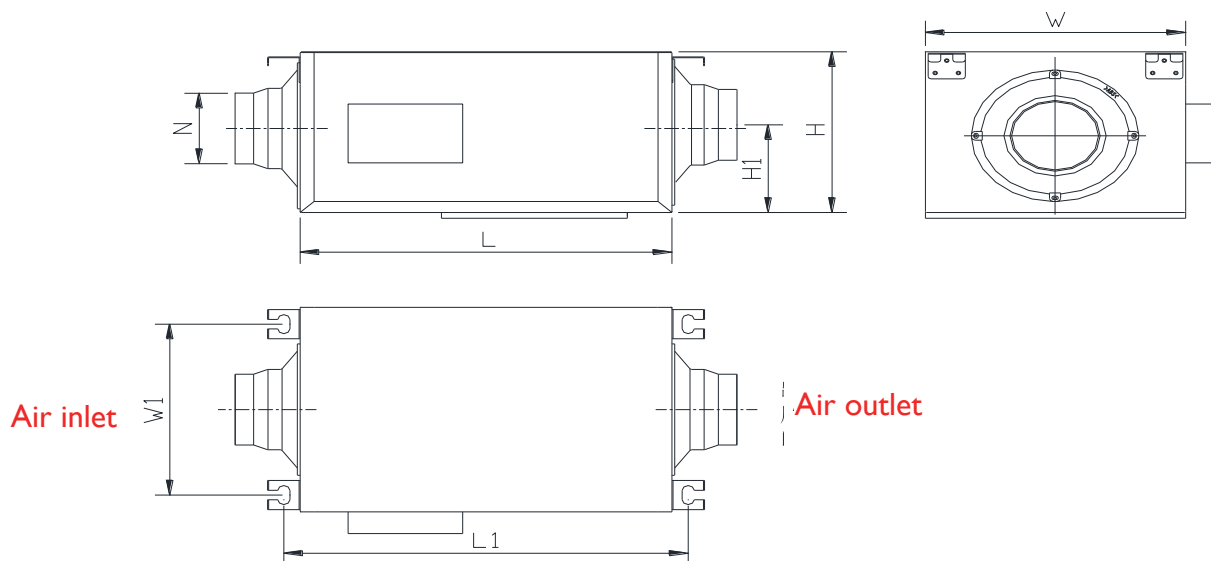

PL

Model	L	L1	W	W1	H	HI	N
MDU 500	400	433	320	282	290	145	198
MDU 1000	400	433	350	291	310	155	242

INSTALLATION CONSIDERATIONS

1. Urządzenie należy zainstalować w kanale powietrznym w połączeniu szeregowym z innymi urządzeniami wentylacyjnymi (takimi jak nawiewnik świeżego powietrza, urządzenie oczyszczające powietrze, itp.).
2. Niezależnie od powodu opóźnienia montażu urządzenia dezynfekcyjnego, a co za tym idzie, jego krótkotrwałego lub długotrwałego składowania w miejscu dostawy, należy podjąć odpowiednie kroki w celu zapobieżenia przedostawaniu się pyłu budowlanego i żwiru do wnętrza urządzenia.
3. Nie montować w pobliżu nagrzewnicy wodnej.
4. Należy unikać następujących błędów instalacyjnych.

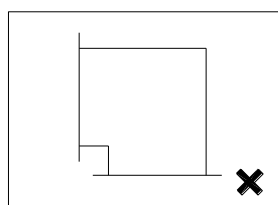

Elbow form

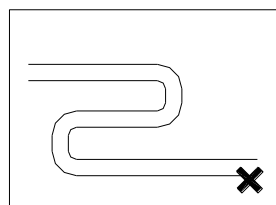
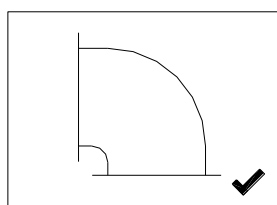

Duct layout

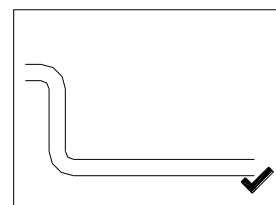

5. Miejsce instalacji: Urządzenie jest połączone z innymi urządzeniami wentylacyjnymi za pomocą rur powietrznych i między tymi dwoma urządzeniami nie należy instalować wylotu powietrza nawiewnego ani wlotu powietrza recyrkulacyjnego.
6. Podłączanie kanału powietrznego: Jeżeli średnica średnicy kanału nie jest zgodna ze średnicą kanału powietrznego instalacji wentylacyjnej, do połączenia przejściowego należy zastosować redukcję kanału. Połączenie między różnymi średnicami rur powinno być zgodne ze wytycznymi projektowymi dotyczącymi kanałów wentylacyjnych (tj. mniej niż 15° po obu stronach)
7. Regulacja ilości powietrza: W celu wyregulowania ilości powietrza, w kanale głównym należy za montować zawory powietrzne, tak aby żaden wentylator systemowy nie kontynuował pracy w przypadku przeciążenia. Im większa ilość powietrza, tym większe obciążenie dla urządzenia dezynfekującego.
8. **It's recommended to use the ventilation equipment with primary filters and F9 filters to work together with the disinfection box for better disinfection effect.**

ELEKTRISCHE INSTALLATION



Achtung

Die Stromzufuhr muss während der Installation und vor der Wartung ausgeschaltet werden, um Verletzungen durch einen elektrischen Stromschlag zu vermeiden. Die Spezifikation der Kabel muss genau eingehalten werden, ansonsten kann das Vorhaben fehlschlagen, es besteht die Gefahr eines elektrischen Schlages oder Brandes.

PL

Stromversorgung ist AC220V/50HZ/I-Phase.



Achtung

Wir übernehmen keine Haftung für elektrische Probleme und die des Betriebssystems, die durch privates und nicht autorisiertes Re-Engineering des Nutzers verursacht werden.

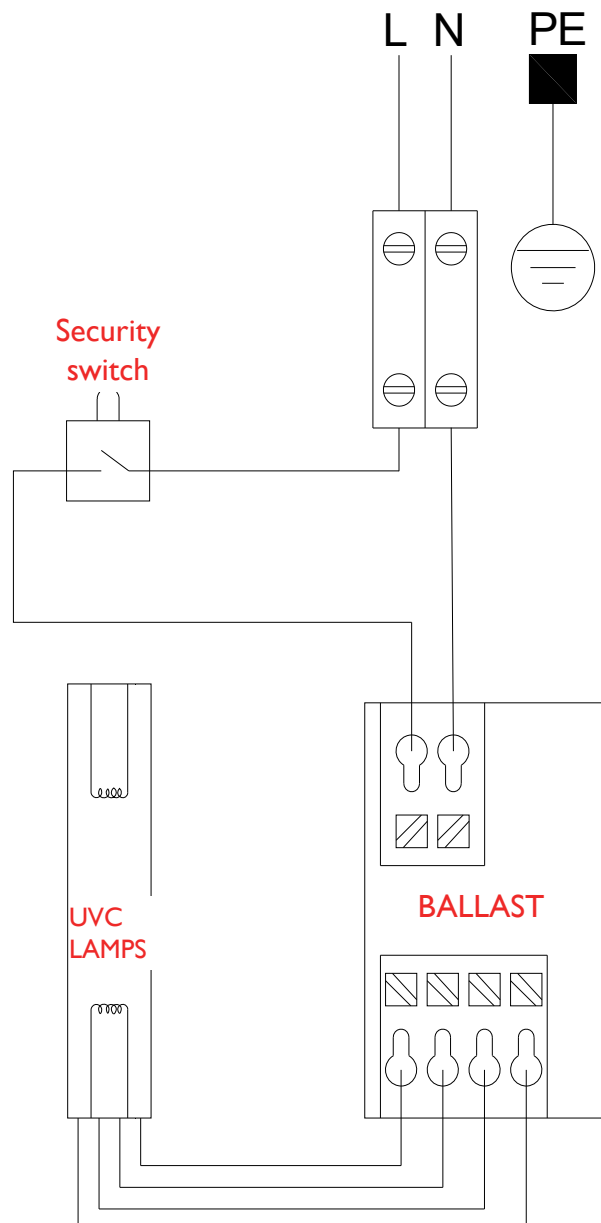

ELEKTRISCHE INSTALLATION

INBETRIEBNAHME

Po wykonaniu instalacji, należy wykonać poniższe czynności w celu przeprowadzenia uruchomienia (należy zlecić ich wykonanie osobie kompetentnej).

1. Najpierw sprawdź, czy okablowanie sprzętu i zasilania są prawidłowo wykonane, tak by upewnić się przed uruchomieniem, że całość okablowania jest wykonana prawidłowo.
2. Przy pomocy miernika uniwersalnego sprawdź, czy zasilanie jest prawidłowe.
3. W przypadku wystąpienia nieprawidłowości podczas uruchamiania, w celu uniknięcia porażenia prądem elektrycznym, należy niezwłocznie wyłączyć urządzenie, odłączyć główne źródło zasilania i dokonać ponownego sprawdzenia .

WŁAŚCIWOŚCI

Światło ultrafioletowe + filtr fotokatalizatora powodują reakcję chemiczną i przekształcają energię świetlną w energię potrzebną do dokonania się reakcji chemicznej, dzięki czemu cząsteczki tlenu i wody mogą zostać przekształcone w utleniające jony ujemne OH i O₂, które następnie powodują rozkład szkodliwego gazu, takiego jak benzen , formaldehyd, itp., oraz niszczą strukturę molekularną DNA i RNA w komórkach mikroorganizmów, tak by te utraciły zdolność namnażania się, a także zabijają rosnące komórki, osiągając tym samym cel sterylizacji i dezynfekcji i przekształcając komórki w nieszkodliwy dwutlenek węgla oraz wodę.

ŚRODKI OSTROŻNOŚCI

1. Podczas konserwacji, przed otwarciem pokrywy rewizyjnej, należy wyłączyć zasilanie, a następnie przeprowadzić konserwację i przegląd.
2. Aby uniknąć obrażeń, podczas konserwacji i naprawy noś rękawice ochronne.
3. Aby uniknąć upadku, na czas konserwacji drabinę należy bezpiecznie przymocować.

INSTALLATION INSTRUCTIONS

(I) INSTALLATION WITH ENERGY RECOVERY VENTILATOR

- 1, Fresh air disinfection box can be used in conjunction with energy recovery ventilator, and work together with interlock control.
- 2, Fresh air disinfection box can sterilize the outdoor or indoor polluted air.
- 3, Fresh air disinfection box is recommended to be installed on the air supply and exhaust ducts first.
- 4, Both ends of fresh air disinfection box need to be connected to the main pipe with hoses.

PL

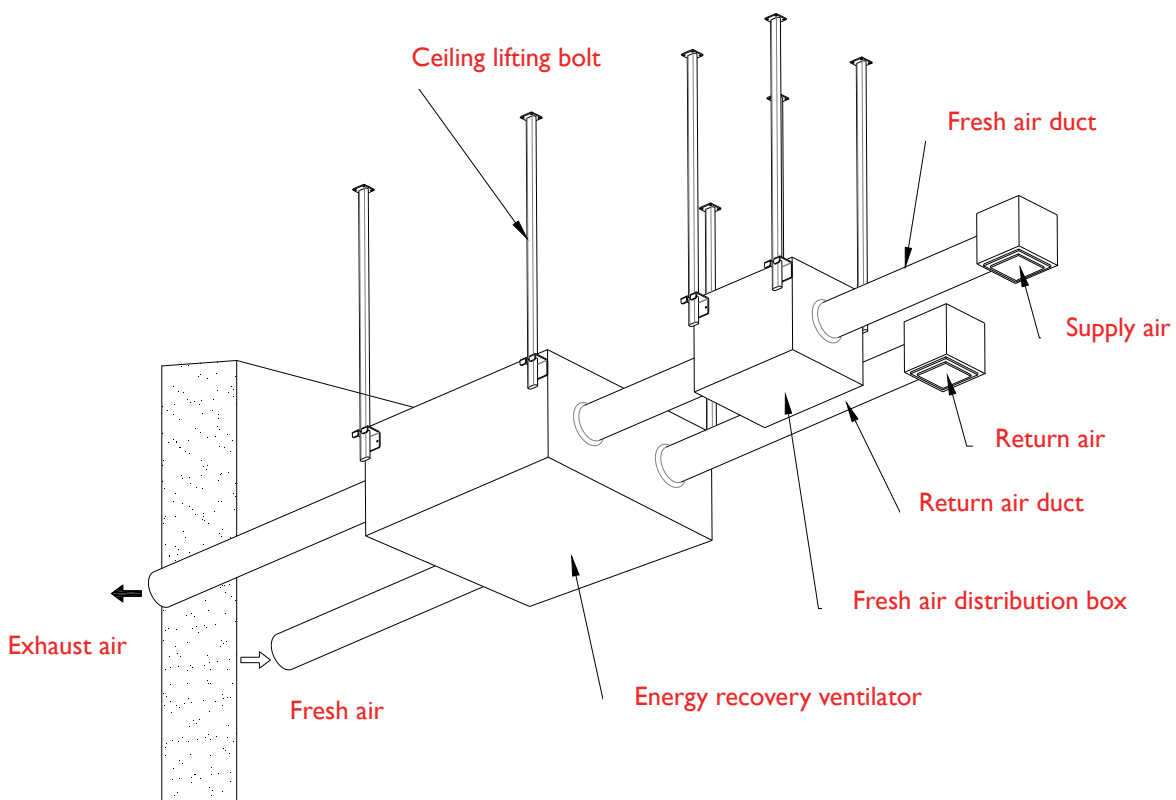

INSTALLATION INSTRUCTIONS

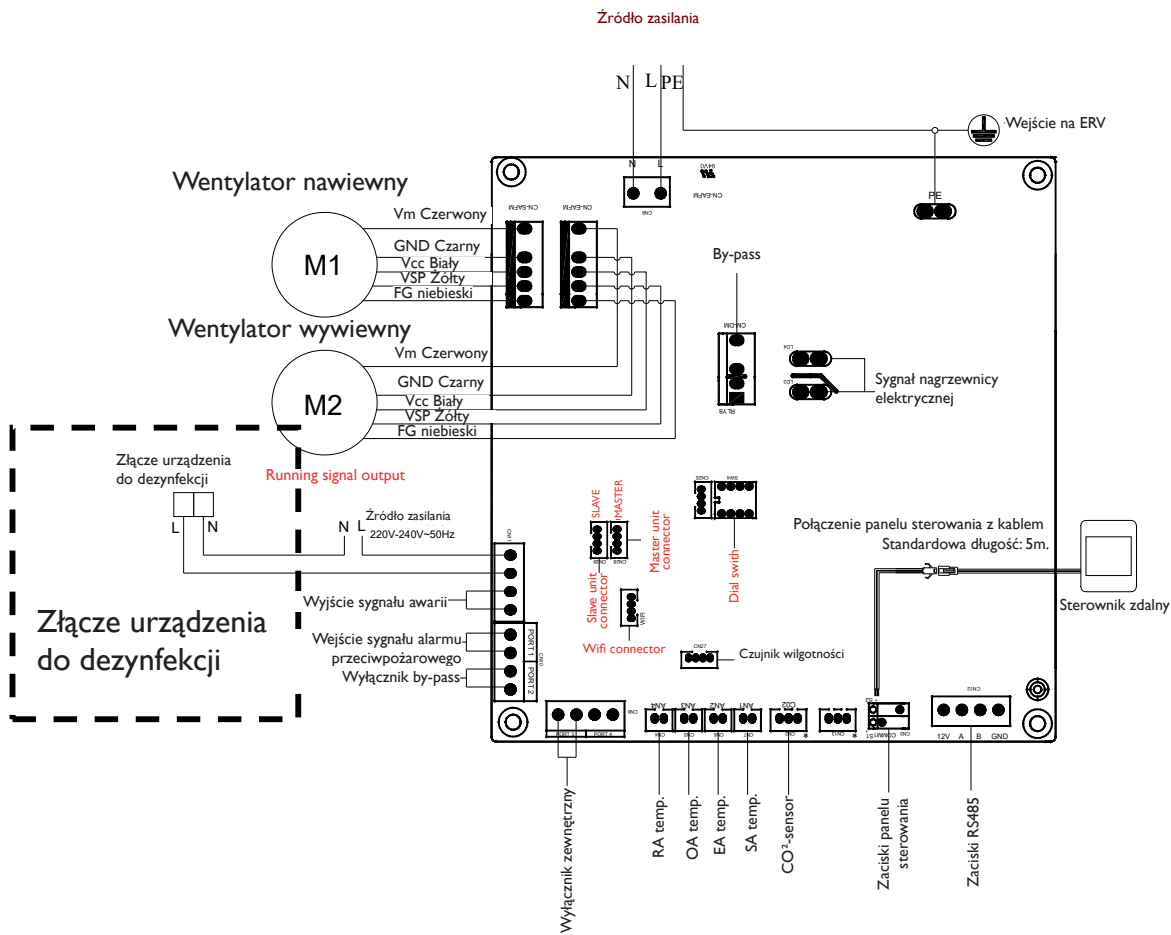

Połączenie ze sterownikiem ERV (DC motor type)

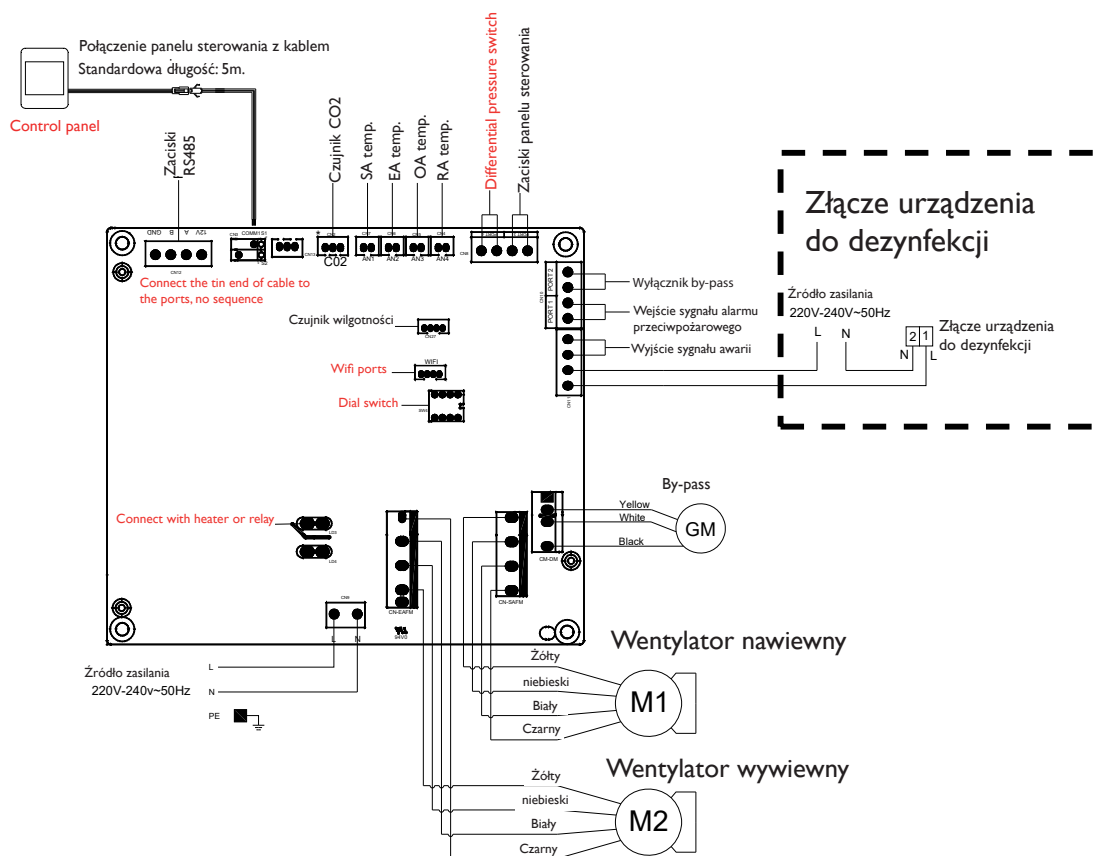

Połączenie ze sterownikiem ERV (AC motor type)

INSTALLATION INSTRUCTIONS

(2) INSTALLATION WITH FRESH AIR FILTRATION BOX

- 1, Fresh air disinfection box can be used in conjunction with fresh air filtration box, and work together with interlock control.
- 2, Fresh air disinfection box can sterilize the outdoor or indoor polluted air.
- 3, Fresh air disinfection box is recommended to be installed after the filtration box.
- 4, Both ends of fresh air disinfection box need to be connected to the main pipe with hoses.

PL

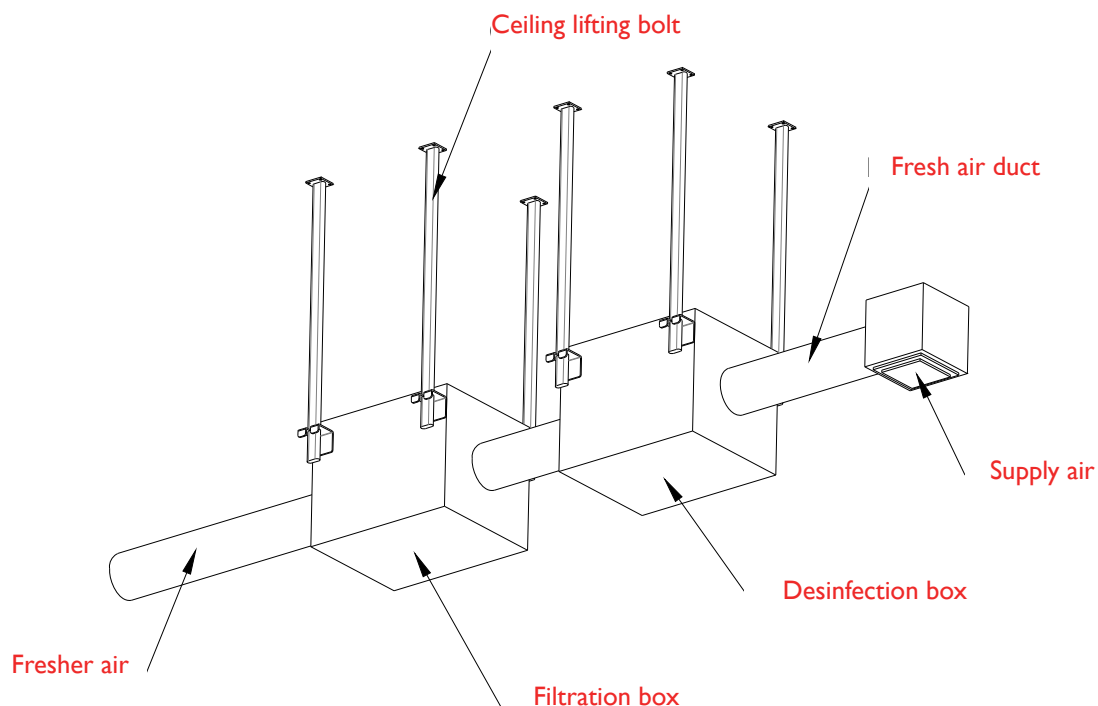

Fresh air filtration box with button controller:

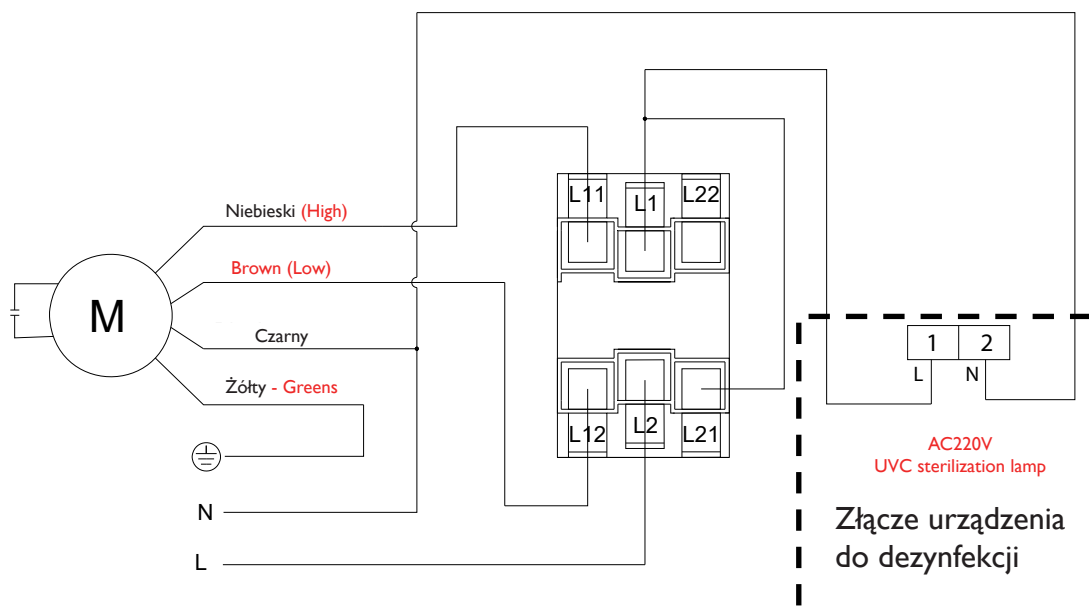

CONTROLS

INDEPENDENT CONTROL

- 1, The disinfection box can be used independently with ON/OFF controller.
- 2, The disinfection box can sterilize the outdoor or indoor polluted air.
- 3, The disinfection box is recommended to be installed after the ventilator or blower.
- 4, Both ends of the disinfection box need to be connected to the main pipe with hoses.

OPTIONAL (I): TOUCH SCREEN CONTROL PANEL

Reference picture:



Installation dimensions:

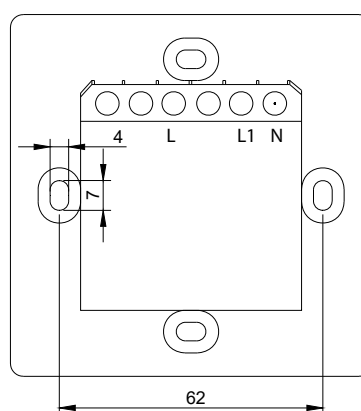
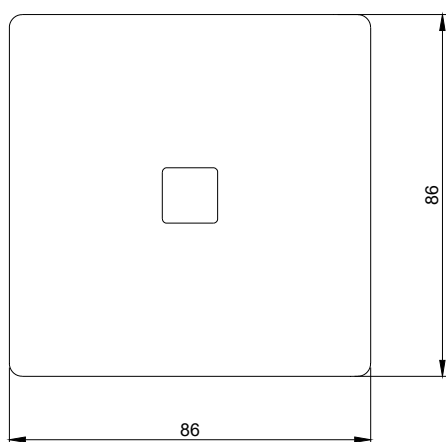

Wiring diagram:

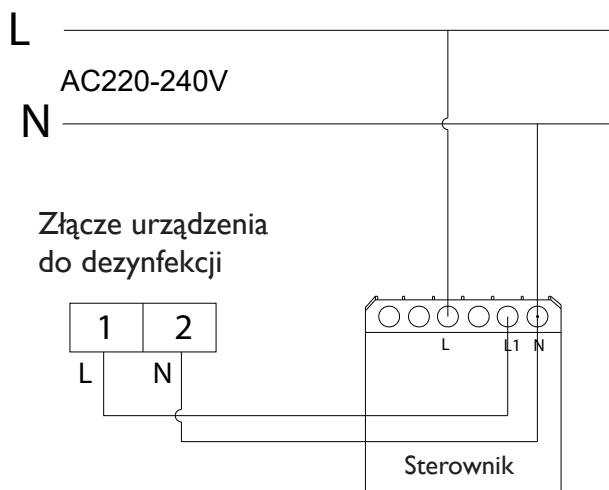

Podłączyć do sterownika on/off

CONTROLS

OPTIONAL (2): BUTTON CONTROL PANEL

Reference picture:



PL

Installation dimensions:

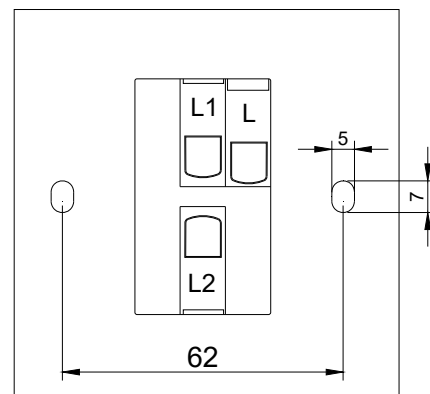
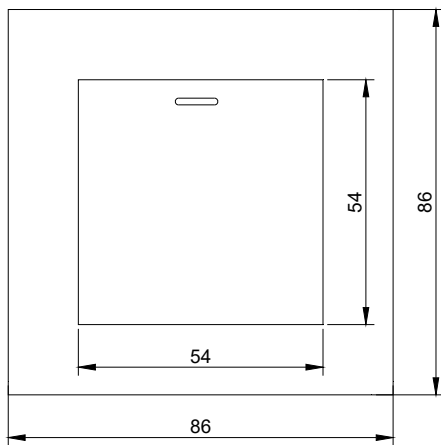



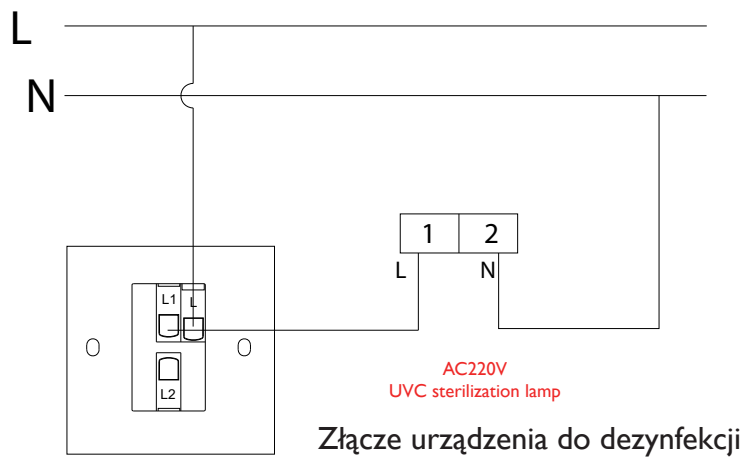



















Wiring diagram:









MASURI DE SIGURANȚĂ







Vă rugăm să citiți următoarele instrucțiuni de siguranță înainte de instalare și asigurați-vă că unitatea este instalată corect. Vă rugăm să respectați toate instrucțiunile pentru a evita rănirea personalului sau deteriorarea echipamentului / bunurilor. Informațiile din acest document pot fi modificate fără notificare prealabilă. Cea mai recentă versiune a acestui manual este întotdeauna disponibilă la www.markclimate.ro/downloads.

Recomandari de siguranta			
Următoarele simboluri indică niveluri potențiale de precauție.			
 Warning	Situații cu risc, deces sau rănire gravă.	 Attention	Situații cu risc de rănire sau echipamente/daune materiale.
Următoarele simboluri indică conformitatea care trebuie respectată.			
	Nu este permis sau STOP	 De urmarit	 sau obligatii
 Avertizare			
	Instalarea trebuie efectuată de către o persoană calificată. Utilizatorii finali nu trebuie să instaleze, să mute sau să reinstaleze singuri acest echipament.		O plasă anti-pasăre sau un dispozitiv similar trebuie instalate pe orificiile de ventilație exterioare. Asigurați-vă că nu există obturări la sau în tubulaturi.
	Personalul care montează echipamentul, trebuie să urmeze cu strictete acest manual. Acțiunea necorespunzătoare poate crea un pericol pentru sănătate și poate reduce eficiența unității.		Grila de aer proaspăt trebuie să fie suficient de departe de orice evacuare a gazelor de ardere sau de zonele în care sunt prezenți vapori periculoși.
	Unitatea trebuie instalată urmând instrucțiunile din acest manual și montată pe suporturi antivibranti care corespund greutății unității.		Electricienii trebuie să respecte reglementările naționale și manualul, să utilizeze cabluri speciale. Cablurile subdimensionate și necorespunzătoare pot provoca electrocutare sau incendiu.
	În timpul întreținerii sau reparării, unitatea și întrerupătorul de circuit trebuie oprite.		Împământarea nu poate fi conectată la țevă de gaz, țevă de apă, țijă de iluminat sau linie telefonică etc. Împământarea incorectă poate provoca electrocutare.
 Atenție			
	Cablul de alimentare și legăturile electrice trebuie efectuate de personal calificat. Conectarea necorespunzătoare poate provoca supraîncălzire și poate duce la incendiu sau scăderea eficienței.		Pentru a evita condensul, tubulatura de aer proaspăt trebuie izolată. Alte tubulaturi pot necesita, de asemenea, izolație în funcție de condițiile "punct de rouă".
	În cazul în care tubulatura metalică străpunge un perete metalic, tubulatura trebuie izolată pentru a evita riscul de electrocutare sau de scurgere a curentului.		Capacul cutiei de borne trebuie apăsat și închis pentru a evita pătrunderea prafului și murdăriei. Excesul de praf și murdărie poate provoca supraîncălzirea terminalelor și poate duce la incendiu sau electrocutare.
	Utilizați numai hardware și accesorii de instalare aprobate. Nerespectarea poate duce la risc de incendiu, electrocutare și defectarea echipamentului.		În cazul în care unitatea este poziționată, la plafon, într-o încălțimă umedă, vă rugăm să vă asigurați că este disponibilă o ventilație suficientă.
	Tubulatura exterioară trebuie instalată și protejată astfel încât să poată fi evitată pătrunderea apei de ploaie. Instalarea necorespunzătoare poate cauza scurgeri de apă.		De asemenea, trebuie montat un BMC dimensionat corect pe unitatea de protecție adecvată împotriva scurgerilor de pământ, pentru a se evita riscul de electrocutare sau incendiu.

MASURI DE SIGURANȚĂ

 Atenție	
 Nu instalați aparatul în condiții de umiditate ridicată, deoarece poate duce la electrocutare și prezintă un risc de incendiu.	 Nu utilizați unitățile pentru evacuare aer din bucatarii, deoarece vaporii de grasime pot obtura schimbătorul de căldură sau filtrele și poate prezenta un risc de incendiu.
 Nu instalați aparatul în zonele unde există gaze toxice sau caustice.	 Nu instalați aparatul în apropierea flăcării deschise, deoarece aceasta poate duce la supraîncălzire și prezintă un risc de incendiu.
 Mediile acide sau alcaline pot provoca intoxicații sau incendiu.	 Tensiunea nominală de alimentare trebuie menținută constant și în limite normale, în caz contrar acest lucru poate provoca incendii.

RO

 Warning	
 Acest aparat poate fi utilizat de copii cu vârsta de peste 8 ani și de persoane cu capacități fizice, senzoriale sau mentale reduse sau lipsă de experiență, doar cu supraveghere sau dacă cunosc instrucțiunile privind utilizarea aparatului într-un mod sigur și înțeleg posibilele riscuri.	
 Nu este indicat accesul copiilor la echipament.	 Curățarea și întreținerea nu ar trebui să fie efectuate de către copii, fără supraveghere
 Mijloacele de deconectare trebuie încorporate în cablajul fix în conformitate cu regulile de cablare	 Înainte de curățare sau întreținere, aparatul trebuie deconectat de la rețeaua de alimentare.

SPECIFICATII

Model	MDU 500	MDU 1000
Debit de aer (m ³ /h)	400~600	600~1300
Presiune disponibilă (Pa)	5	5
Voltage (V)	230	230
Putere (W)	6	7.4
Greutate (Kg)	6	7.8

DIMENSIUNI CONSTRUCTIVE

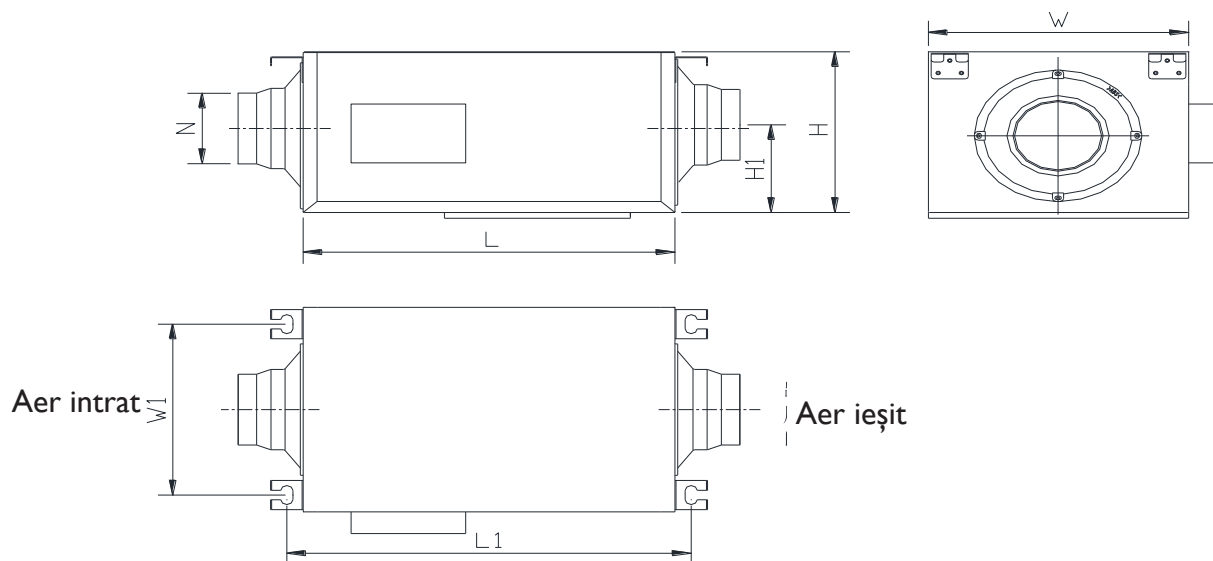

Model	L	L1	W	WI	H	HI	N
MDU 500	400	433	320	282	290	145	198
MDU 1000	400	433	350	291	310	155	242

INSTRUCTIUNI DE INSTALARE

1. Instalat în conducta de aer, în serie, și utilizat împreună cu alte echipamente de ventilație (ventilator cu aport de aer proaspăt, cutie de purificare a aerului etc.)
2. În cazul amânării instalării cutiei de dezinfectare, și depozitarea acesteia pe termen scurt sau lung în diferite spații, trebuie luate măsuri corespunzătoare pentru a preveni pătrunderea prafului sau pietrișului în interiorul echipamentului.
3. Nu instalați în apropierea încălzitorului de apă.
4. Următoarele puncte ar trebui evitate în instalarea proiectului de conducte.

RO

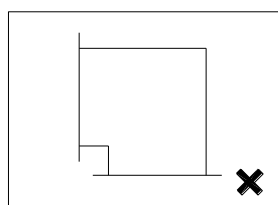

Forma cotului

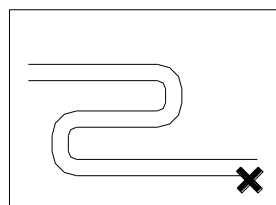
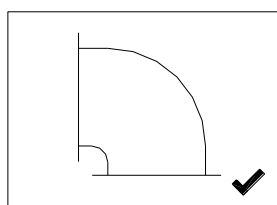

Layout-ul conductelor

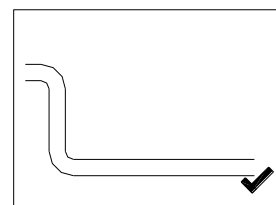

5. Locația de instalare: Echipamentul este conectat cu alte echipamente de ventilație prin conducte de aer, deci nicio conducta de intrare sau retur nu trebuie instalată între cele două echipamente.
6. Conectarea conductei de aer : Dacă diametrul conductei nu este același cu diametrul conductei de aer a sistemului de ventilație, va rugăm să utilizați reductorul pentru tranziția conductei. Conexiunea dintre tevi de diametru diferite trebuie să fie conform cu specificațiile proiectului conductelor de ventilație (mai puțin de 15° pe ambele părți)
7. Reglarea volumului de aer : Supapele de aer trebuie instalate în conducta principală, pentru a regla volumul de aer, astfel încât să se asigure că fiecare ventilator din sistemul de ventilație nu funcționează în condiții de supraîncărcare. Cu cât volumul de aer este mai mare, cu atât este mai mare încărcarea de dezinfectare
8. Se recomandă utilizarea echipamentelor de ventilație cu filtre primare și filtre F9, care împreună cu o cutie de dezinfectare, oferă o dezinfecție mai bună spațiului.

INSTALARE ELECTRICĂ



Avertizare

Tensiunea trebuie oprită în timpul instalării și înainte de întreținere, pentru a evita rănirea prin electrocutare. Specificațiile cablurilor trebuie să corespundă strict cerințelor, în caz contrar aceasta poate provoca defecțiuni și pericol de electrocutare sau incendiu.

Sursa de alimentare este 220V/50HZ/1 Fază.



Avertizare

Nu ne asumăm nicio răspundere pentru problemele cauzate de către personal neautorizat, precum și modificări în schemele electrice și de control.

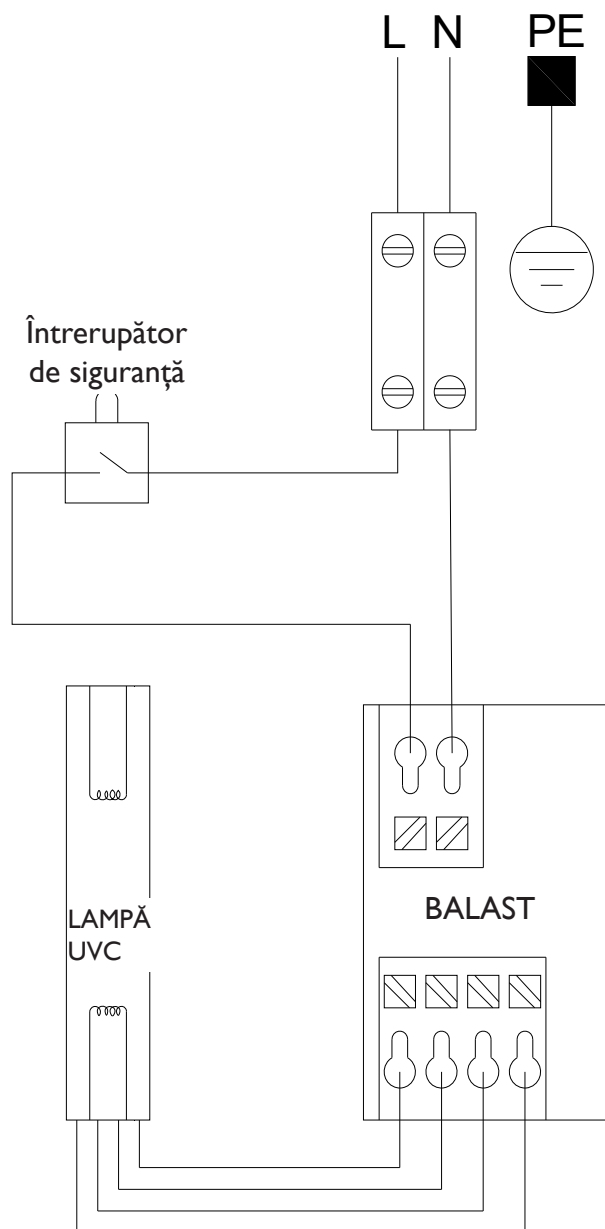

INSTALARE ELECTRICĂ

PUNERE ÎN FUNCȚIUNE

După ce s-a realizat instalarea, urmăriți pașii prezentați pentru punerea în funcțiune. (acțiune ce trebuie efectuată de un profesionist).

1. În primul rând, verificați dacă echipamentele de conectare și de alimentare sunt prezente, pentru a fi sigur că toate legăturile sunt în regulă înainte de punerea în funcțiune.
2. Utilizați un multimetru pentru a vedea dacă alimentarea electrică este în parametrii.
3. În cazul unei probleme apărute în timpul punerii în funcțiune, pentru a evita șocurile electrice, vă rugăm opriți imediat echipamentul și deconectați-l de la sursa principală de alimentare, iar mai apoi verificați din nou.

RO

CARACTERISTICI

Lumina ultravioletă + filtrul fotocatalizator poate stimula reacțiile substanțelor chimice și folosesc energia luminii pentru a o converti în energia necesară pentru reacțiile chimice. Așadar, moleculele de apă sunt transformate în OH și ioni liberi negativi de oxigen, care pot descompune gaze nocive precum benzenul. Totodată, poate distruge structura moleculară a ADN-ului și ARN-ului din celulele microorganismelor, pentru a le determina să piardă capacitatea de reproducere și să omoare celulele în creștere, astfel sterilizându-le și transformându-le în dioxid de carbon nepericulos și apă.

PRECAUȚII

1. În timpul lucrărilor de mentenanță, înainte de a deschide capacul de inspecție, asigurați-vă că opriți alimentarea, și doar după aceea efectuați mentenanța și inspecția.
2. În timpul lucrărilor de mentenanță sau a reparațiilor, asigurați-vă că purtați manșuri de protecție pentru a evita rănirea mâinilor.
3. În timpul lucrărilor de mentenanță, vă rugăm să fixați scara pentru a evita căderea de la înălțime.

INSTRUCȚIUNI DE INSTALARE

(I) INSTALARE CU VENTILATOR DE RECUPERARE A ENERGIEI

1. Cutia de dezinfectare cu aer proaspăt poate fi utilizată împreună cu ventilatorul de recuperare a energiei și poate fi controlată cu un interlock control.
2. Cutia de dezinfectare pentru aerul proaspăt poate steriliza aerul poluat, din interior sau din exterior.
3. Cutia de dezinfectare cu aer proaspăt este recomandat să fie instalată pe admisia aerului so pe refulare mai întâi
4. Ambele capete ale cutiei de dizinfecare pentru aer proaspăt trebuie conectate la conduct principală printr-un furtun.

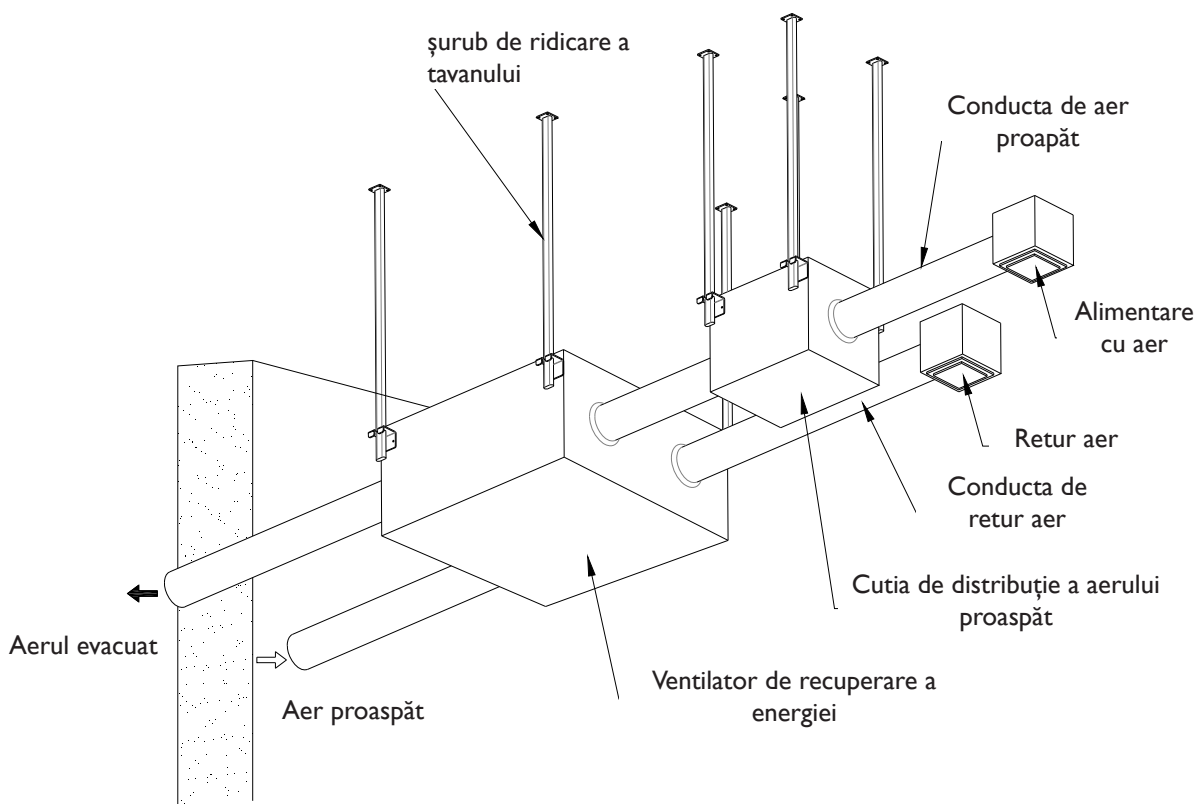

INSTRUCȚIUNI DE INSTALARE

RO

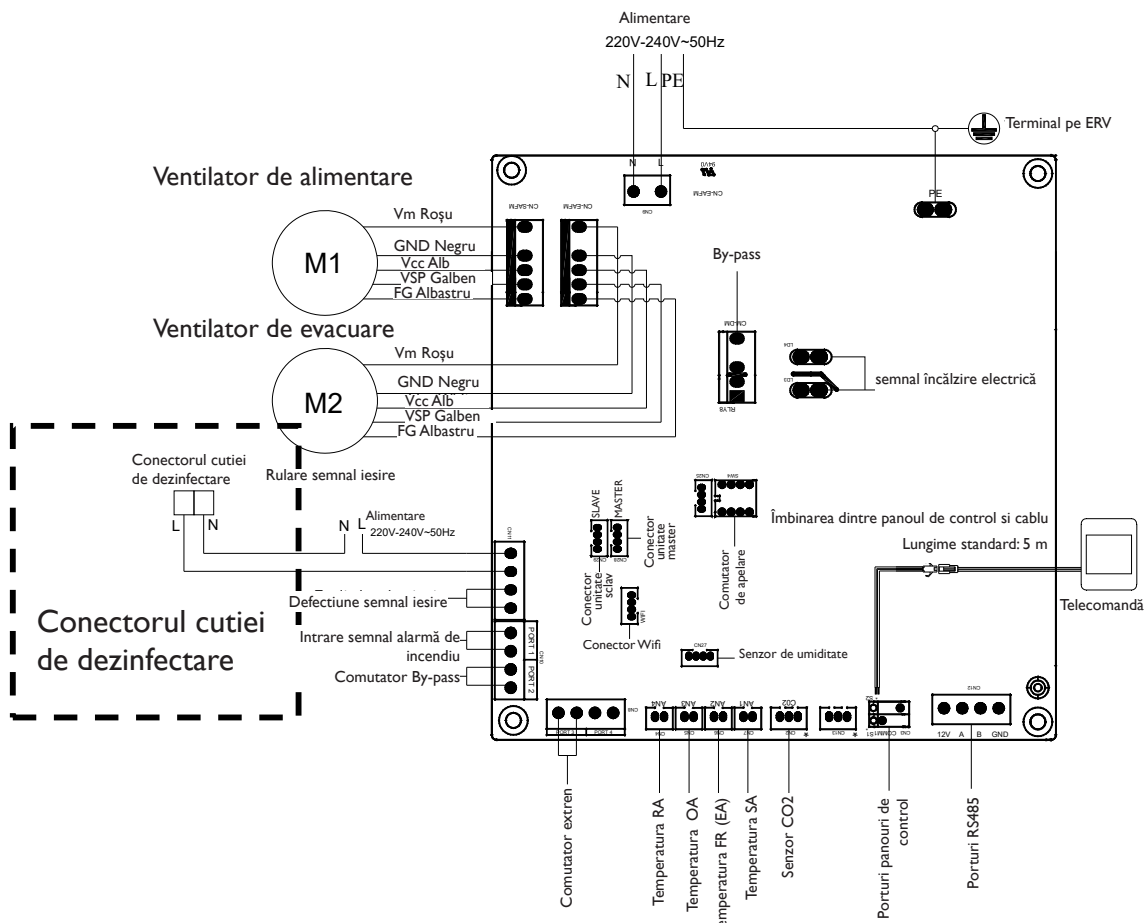

Interlock cu controller ERV (motor DC)

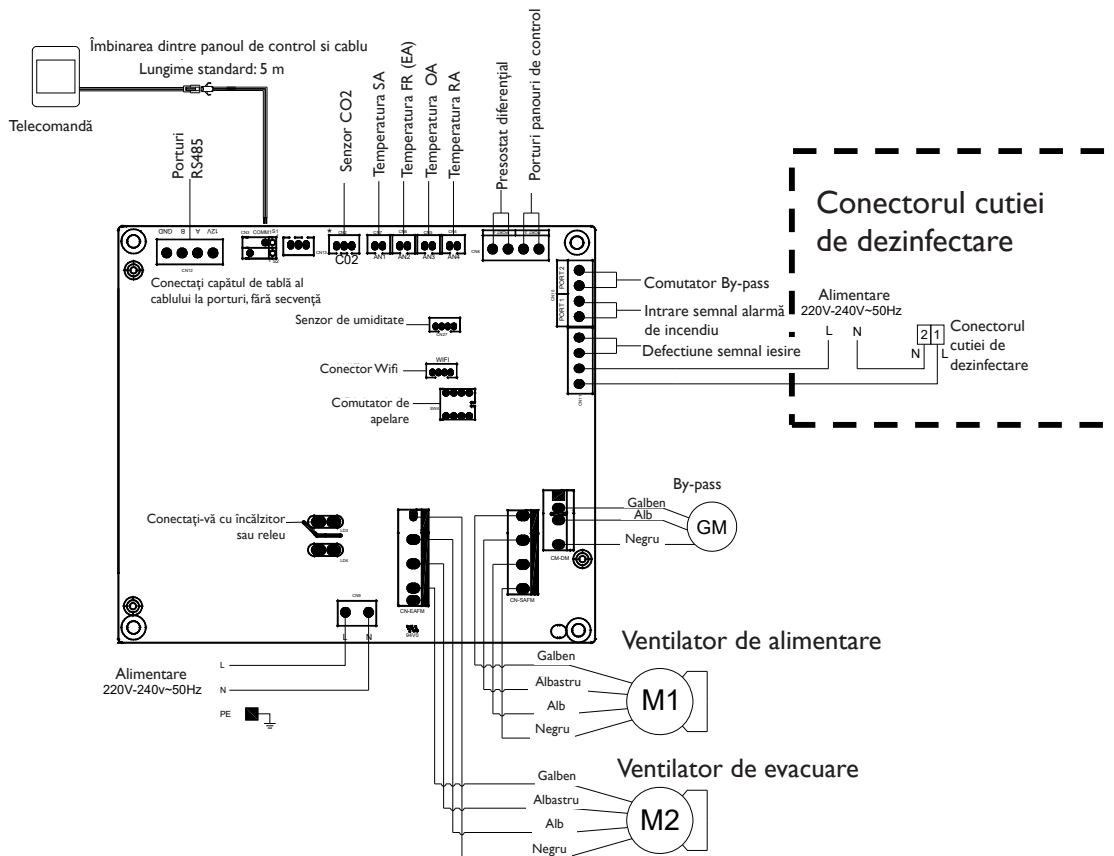

Interlock cu controller ERV (motor AC)

INSTRUCȚIUNI DE INSTALARE

(2) INSTALARE CU CUTIE FILTRANTĂ PENTRU AER PROASPĂT

- 1, Cutia de dezinfectare pentru aer proaspăt poate fi utilizată împreună cu cutie filtrantă pentru aer proaspăt, putând fi controlate ambele de un interlock control.
- 2, Cutia de dezinfectare pentru aerul proaspăt poate steriliza aerul poluat, din interior sau din exterior.
- 3, Cutia de dezinfectare cu aer proaspăt este recomandat să fie instalată după cutia de filtrare.
- 4, Ambele capete ale cutiei de dizinfecare trebuie conectate la conduct principală printr-un furtun.

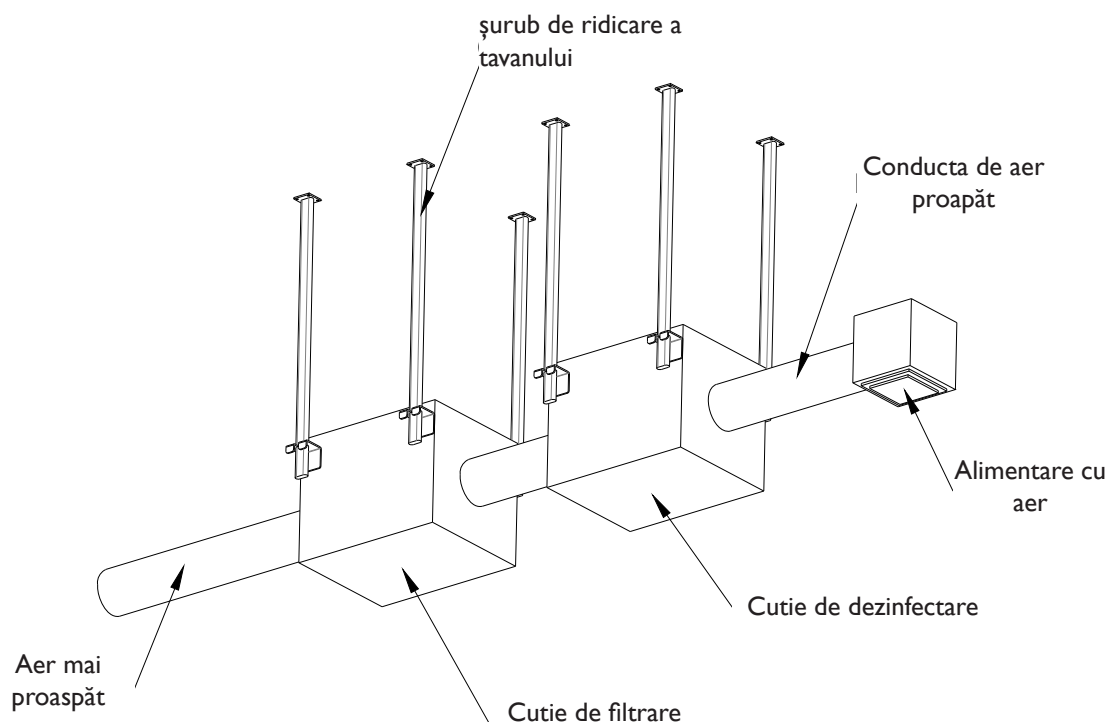

Cutie de filtrare a aerului cu buton

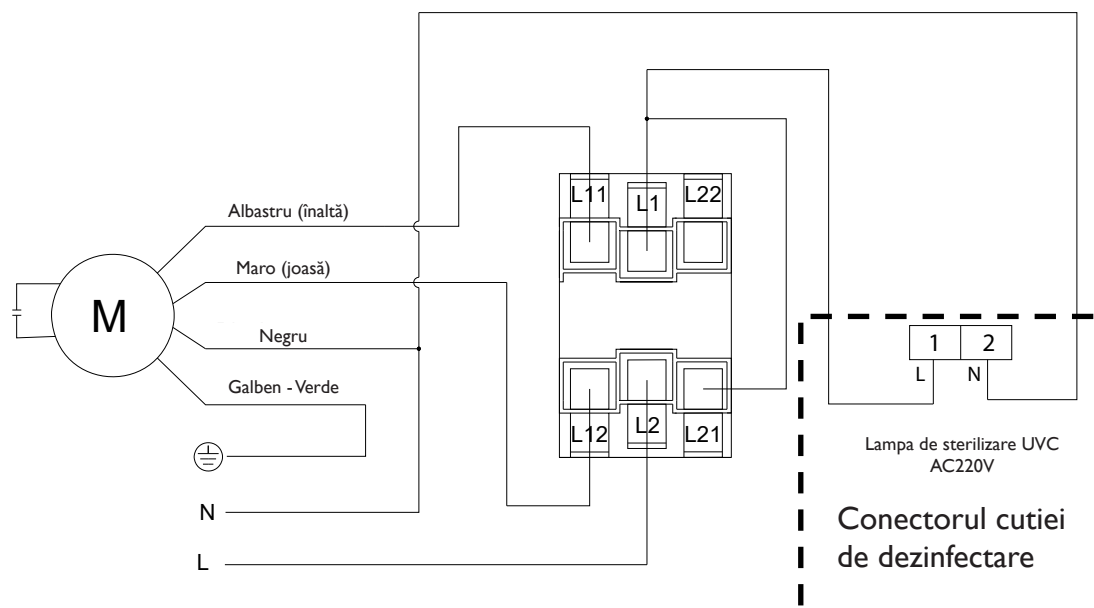

CONTROLERE

CONTROL SEPARAT

- 1, Cutia de dezinfectare poate fi utilizată și separat cu ajutorul unui controller ON/OFF .
- 2, Cutia de dezinfectare poate steriliza aerul poluat din interior sau exterior.
- 3, Se recomandă instalarea cutiei de dezinfectare după ventilator sau suflantă.
- 4, Ambele capete ale cutiei de dizinfecare trebuie conectate la conduct principală printr-un furtun.

RO

OPȚIONAL (I): PANOU DE COMANDĂ CU TOUCH SCREEN

Imagine de referință



Dimensiuni de instalare:



Diagrama electrică:



Conectare la controler on/ off

CONTROLERE

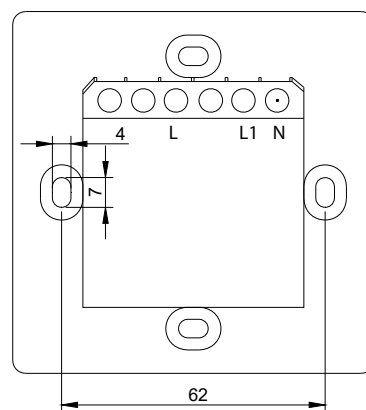
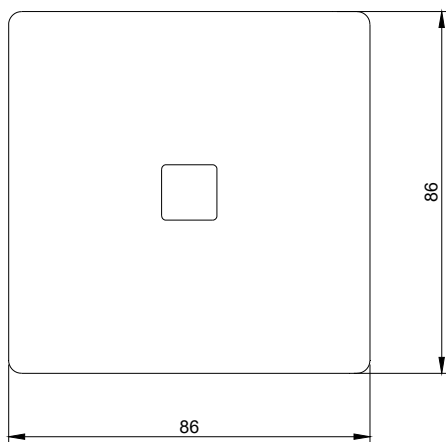
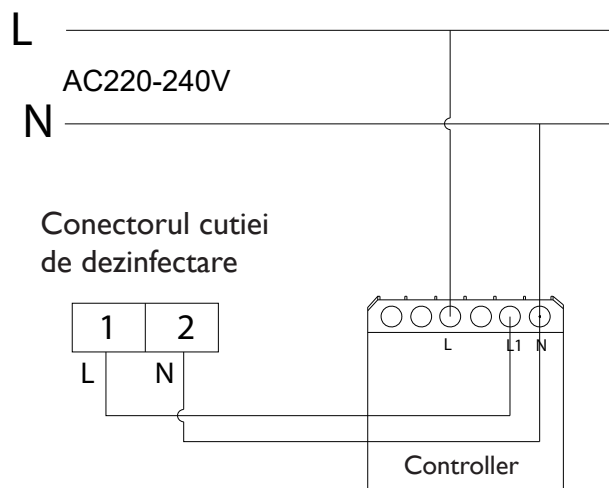
OPTIONAL(2): PANOUL DE CONTROL CU BUTON

Imagine de referință



Dimensiuni de instalare:



Diagrama electrică:



MARK BV

BENEDEN VERLAAT 87-89
VEENDAM (NEDERLAND)
POSTBUS 13, 9640 AA VEENDAM
TELEFOON +31(0)598 656600
FAX +31 (0)598 624584
info@mark.nl
www.mark.nl

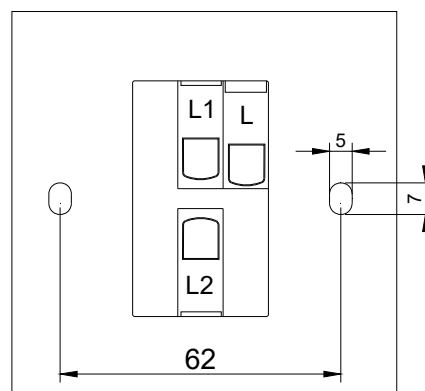
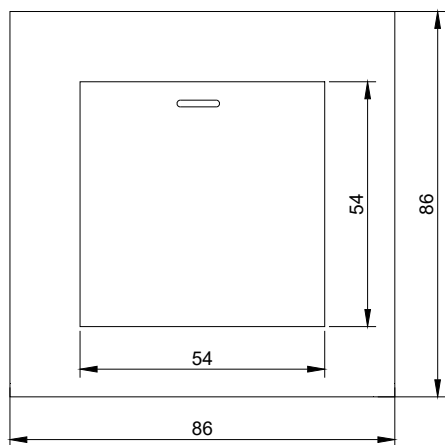
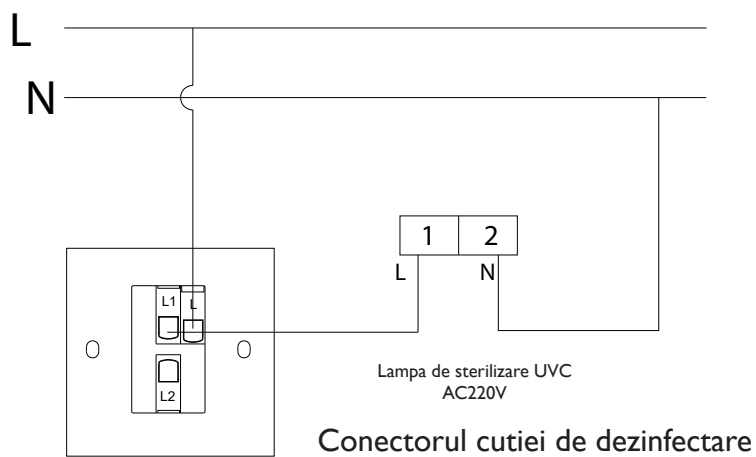
MARK EIRE BV

COOLEA, MACROOM
CO. CORK
PI2 W660 (IRELAND)
PHONE +353 (0)26 45334
FAX +353 (0)26 45383
sales@markeire.com
www.markeire.com

MARK BELGIUM b.v.b.a.

ENERGIELAAN 12
2950 KAPELLEN
(BELGIË/BELGIQUE)
TELEFOON +32 (0)3 6669254
info@markbelgium.be
www.markbelgium.be

MARK DEUTSCHLAND GmbH

MAX-PLANCK-STRASSE 16
46446 EMMERICH AM RHEIN
(DEUTSCHLAND)
TELEFON +49 (0)2822 97728-0
TELEFAX +49 (0)2822 97728-10
info@mark.de
www.mark.de

MARK POLSKA Sp. z o.o

UL. KAWIA 4/16
42-200 CZĘSTOCHOWA (POLSKA)
PHONE +48 34 3683443
FAX +48 34 3683553
info@markpolska.pl
www.markpolska.pl

MARK SRL ROMANIA

STR. BANEASA NO 8 (VIA STR. LIBERTATII)
540199 TÂRGU-MURES, JUD MURES
(ROMANIA)
TEL/FAX +40 (0)265-266.332
office@markromania.ro
www.markromania.ro

